

Please check the examination details below before entering your candidate information

Candidate surname

Other names

Centre Number

Candidate Number

--	--	--	--	--

--	--	--	--

Pearson Edexcel Level 1/Level 2 GCSE (9–1)

Time 1 hour 30 minutes

Paper
reference

1MA1/2F

Mathematics PAPER 2 (Calculator) Foundation Tier

You must have: Ruler graduated in centimetres and millimetres, protractor, pair of compasses, pen, HB pencil, eraser, calculator. Tracing paper may be used.

Total Marks

Instructions

- Use **black** ink or ball-point pen.
- **Fill in the boxes** at the top of this page with your name, centre number and candidate number.
- Answer **all** questions.
- Answer the questions in the spaces provided – *there may be more space than you need.*
- You must **show all your working**.
- Diagrams are **NOT** accurately drawn, unless otherwise indicated.
- **Calculators may be used.**
- If your calculator does not have a π button, take the value of π to be 3.142 unless the question instructs otherwise.



Information

- The total mark for this paper is 80
- The marks for **each** question are shown in brackets – *use this as a guide as to how much time to spend on each question.*

Advice

- Read each question carefully before you start to answer it.
- Try to answer every question.
- Check your answers if you have time at the end.

Turn over ►

P64631A

©2021 Pearson Education Ltd.

E:1/1/1/1/1/1/1/



Pearson

Answer ALL questions.

Write your answers in the spaces provided.

You must write down all the stages in your working.

1 Write 31% as a fraction.

$$\frac{31}{100}$$

(Total for Question 1 is 1 mark)

2 Change 3 metres into centimetres.

300

centimetres

(Total for Question 2 is 1 mark)

3 Write the following numbers in order of size.
Start with the smallest number.

1.02 0.12 1.20 0.21

0.12 0.21 1.02 1.20

(Total for Question 3 is 1 mark)

4 (a) Simplify $m + m + m + m$

4m

(1)

(b) Simplify $12p \div 4$

3p

(1)

(Total for Question 4 is 2 marks)

DO NOT WRITE IN THIS AREA

DO NOT WRITE IN THIS AREA

DO NOT WRITE IN THIS AREA



5 The diagram shows a rectangle.

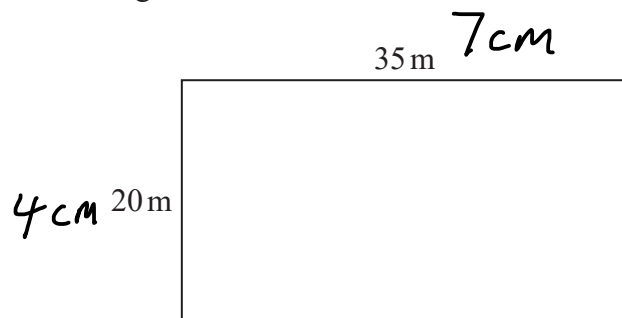

On the centimetre grid below, draw an accurate scale drawing of this rectangle.
Use a scale of 1 cm to represent 5 m.

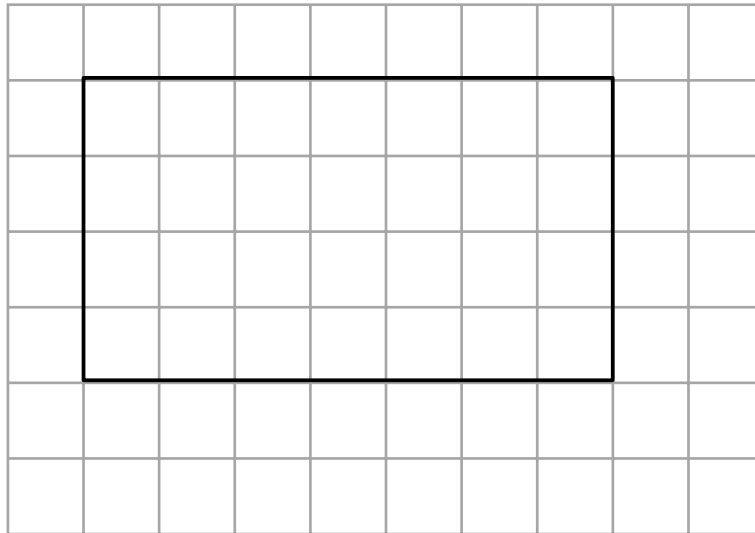

(Total for Question 5 is 2 marks)



6 Here is a list of whole numbers from 21 to 30

21 22 23 24 25 26 27 28 29 30

(a) From the list, write down a square number.

$$25 = 5 \times 5$$

25

(1)

(b) From the list, write down a multiple of 8

$$24 = 3 \times 8$$

24

(1)

(Total for Question 6 is 2 marks)

7 A baker has three bags of flour, A, B and C.

Bag A and bag B contain the same amount of flour.

Bag C contains 940 g of flour.

In the three bags, there is a total of 2500 g of flour.

Work out the amount of flour in bag A.

$$2500 - 940 = 1560$$

$$\frac{1560}{2} = \underline{\underline{780}}$$

780

g

(Total for Question 7 is 3 marks)



- 8 5 students throw a dice.
They each throw the dice the same number of times.

The diagram gives information about the number of times the dice lands on each number.

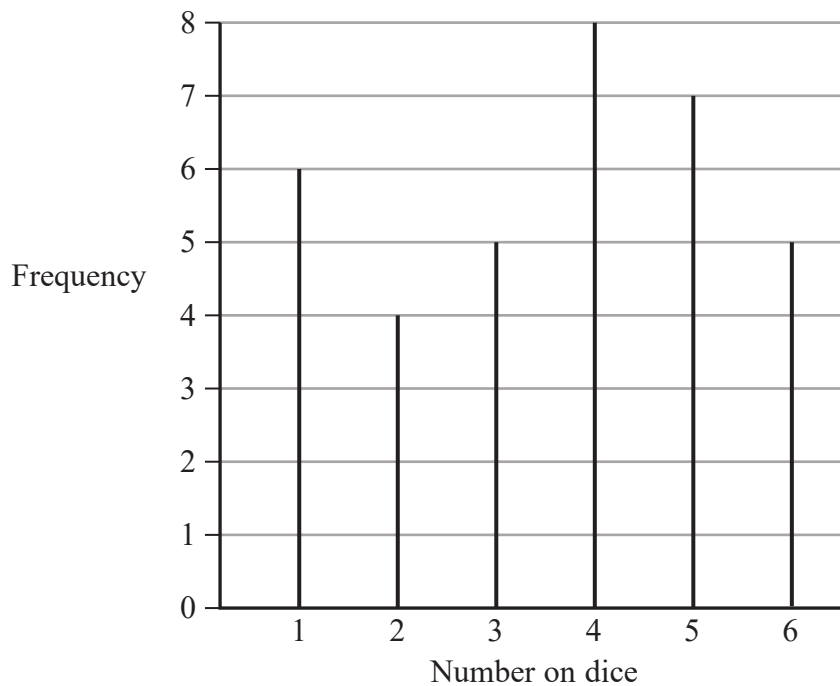

Work out how many times each student throws the dice.

$$6 + 4 + 5 + 8 + 7 + 5 = 35$$

(total throws)

$$35 \div 5 = 7$$

..... 7

(Total for Question 8 is 3 marks)



9 Alec needs to work out the value of $2 + 3 \times 4$

He writes

$$2 + 3 = 5 \text{ and } 5 \times 4 = 20, \text{ so } 2 + 3 \times 4 = 20$$

Alec is wrong.

Explain why.

He should multiply first $3 \times 4 = 12$
then $2 + 12 = \underline{\underline{14}}$

(Total for Question 9 is 1 mark)

10 Write 17 as a fraction of 30

$$\frac{17}{30}$$

(Total for Question 10 is 1 mark)

11 Reflect shape A in the mirror line.

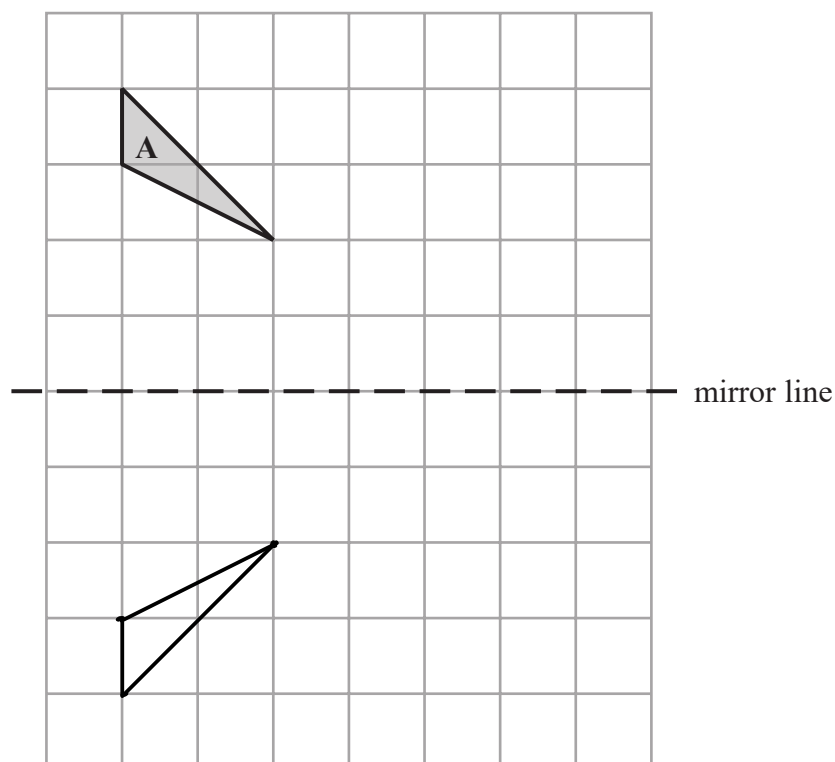

(Total for Question 11 is 2 marks)



12 (a) Work out $\sqrt{\frac{13.82}{4.06}}$

Write down all the figures on your calculator display.

1.844977205

(2)

(b) Give your answer to part (a) correct to 2 decimal places.

1.84

(1)

(Total for Question 12 is 3 marks)

13

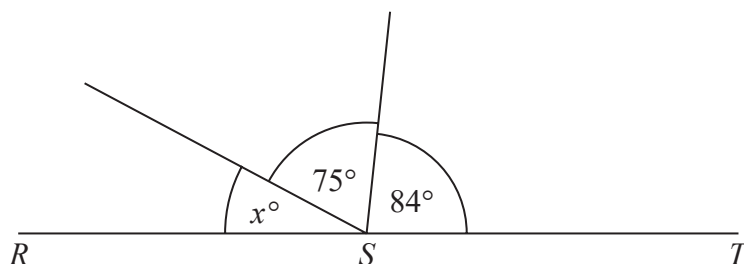

RST is a straight line.

(i) Work out the value of x .

$$180 - 84 - 75$$

21

(2)

(ii) Give a reason for your answer.

Angles on a straight line add to 180°

(1)

(Total for Question 13 is 3 marks)



14 Nazima uses this graph to find out how much money she is paid for the number of hours she has worked.

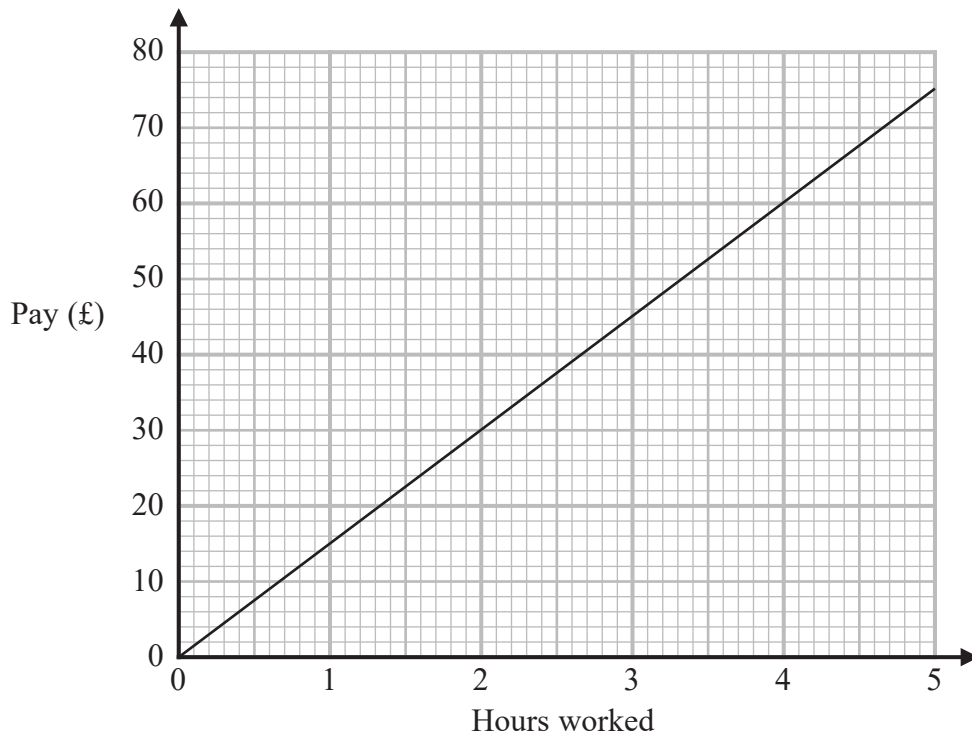

(a) How much money is Nazima paid for each hour she works?

£ 15
(1)

Last week Nazima worked for 36 hours.

(b) How much money was Nazima paid?

$$36 \times 15$$

£ 540
(2)

(Total for Question 14 is 3 marks)



- 15 Write the following fractions in order of size.
Start with the smallest fraction.

$$\frac{5}{8} \quad \frac{2}{3} \quad \frac{4}{9} \quad \frac{3}{5}$$
$$0.625 \quad 0.\dot{6} \quad 0.\dot{4} \quad 0.6$$

$$\frac{4}{9} \quad \frac{3}{5} \quad \frac{5}{8} \quad \frac{2}{3}$$

(Total for Question 15 is 2 marks)



16 The pie chart gives information about the colour of each car in a car park.

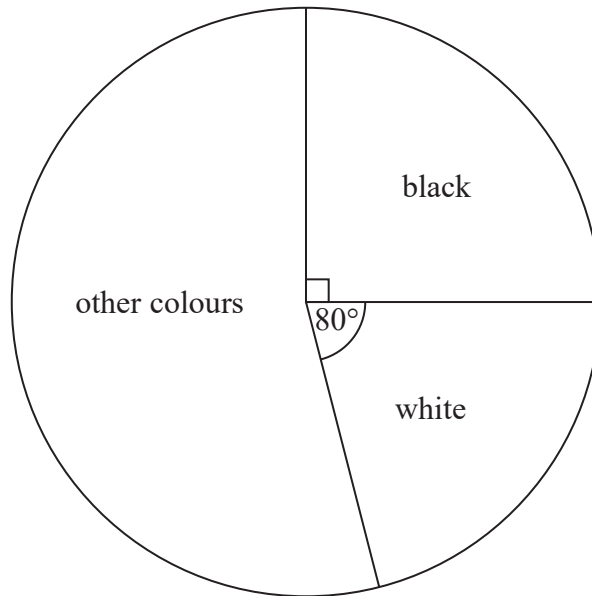

There are 135 black cars in the car park.

(a) Work out the number of white cars in the car park.

$$\frac{1}{4} \text{ of cars} = 135$$

$$\frac{1}{4} x = 135$$

$$x = 540$$

540 cars

$$\frac{80}{360} \times 540 = 120$$

$$\begin{array}{r} 120 \\ \hline (3) \end{array}$$

There are 50 grey cars in the car park.

A car in the car park is picked at random.

(b) Find the probability that this car is grey.

$$\begin{array}{r} 50 \\ \hline 540 \\ \hline (2) \end{array}$$

(Total for Question 16 is 5 marks)



DO NOT WRITE IN THIS AREA

DO NOT WRITE IN THIS AREA

DO NOT WRITE IN THIS AREA

17 60 people are asked if they prefer to text or to email their friends.

38 of the people are women and the rest are men.
15 of the men prefer to email their friends.
60% of the people prefer to text their friends.

Complete the frequency tree for this information.

$$60\% \text{ of } 60 = 0.6 \times 60 = 36$$

$$36 - 7 = 29$$

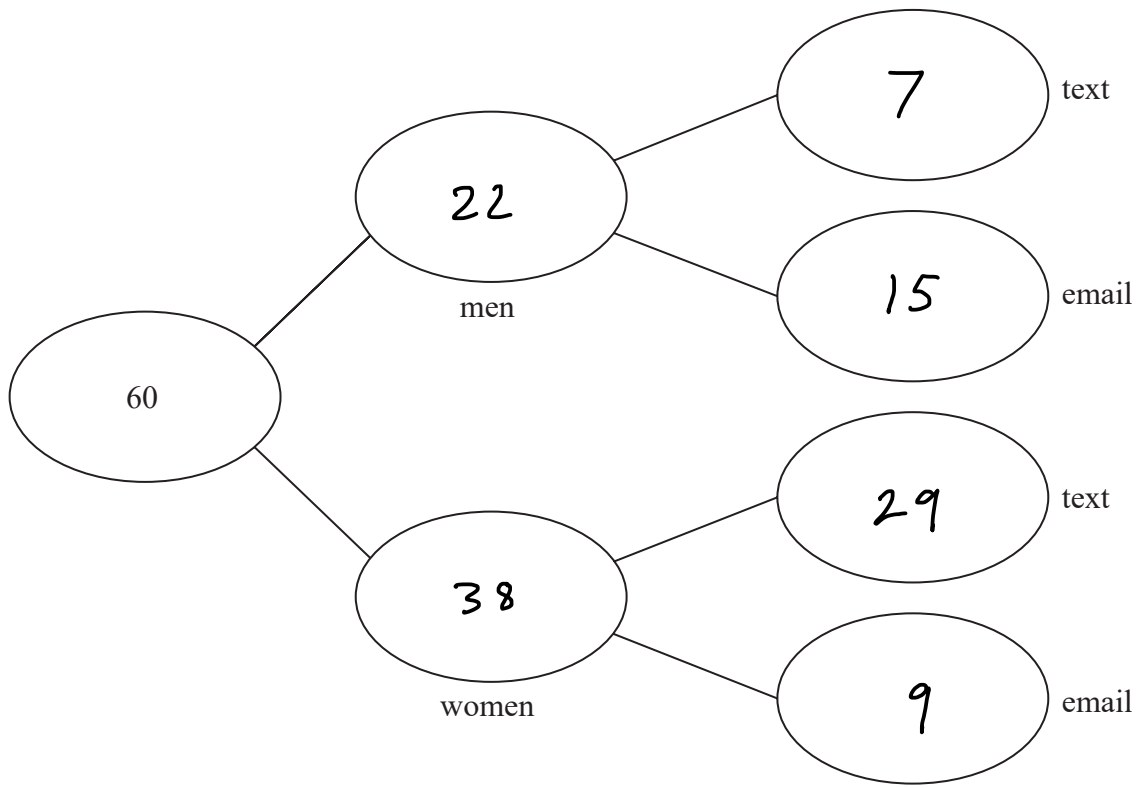

(Total for Question 17 is 5 marks)



18 The incomplete table gives some information about the lengths of the planks of wood in Ben's workshop.

Length of plank (metres)		Number of planks
3	x	5
2.5	x	8
2		
1.5	x	14
1	x	10

15

20

21

10

The total length of these planks is 92 metres.

Work out the number of planks of length 2 metres in Ben's workshop.

$$15 + 20 + 21 + 10 = 66$$

$$92 - 66 = 26$$

$$26 \div 2 = 13$$

13

(Total for Question 18 is 3 marks)

DO NOT WRITE IN THIS AREA

DO NOT WRITE IN THIS AREA

DO NOT WRITE IN THIS AREA



19 Rachel, Samina and Tom share £600 between them.

Rachel gets $\frac{2}{5}$ of the £600 $\frac{2}{5} \times 600 = 240$

Samina gets $\frac{1}{4}$ of the money that is left over.

Tom gets the rest of the money.

Tom says,

“I would have got more money if we had shared the £600 equally between us.”

Is Tom correct?

You must show how you get your answer.

$$600 - 240 = 360$$

$$\text{Samina: } \frac{1}{4} \times 360 = 90$$

$$\text{Tom: } 600 - 240 - 90 = 270$$

$$600 \div 3 = 200$$

$$\text{No. } 270 > 200$$

(Total for Question 19 is 4 marks)

DO NOT WRITE IN THIS AREA

DO NOT WRITE IN THIS AREA

DO NOT WRITE IN THIS AREA



P 6 4 6 3 1 A 0 1 3 2 0

20 (a) Simplify $c^5 \div c^2$

$$c^3$$

(1)

(b) Simplify $(d^4)^3$

$$d^{12}$$

(1)

(Total for Question 20 is 2 marks)

21 (a) Write down the inequality shown on this number line.

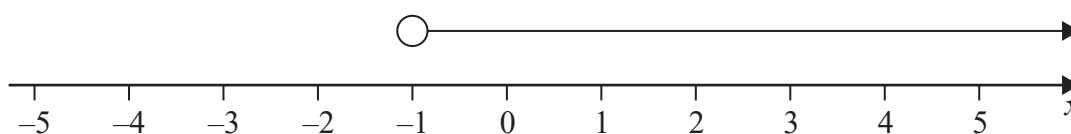

$$x > -1$$

(1)

(b) On the number line below, show the inequality $-3 \leq y < 4$

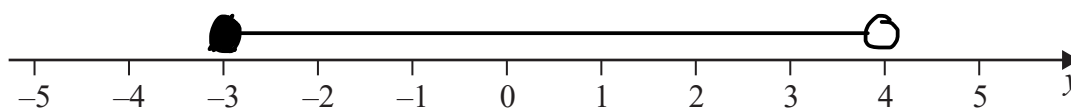

(2)

(Total for Question 21 is 3 marks)



DO NOT WRITE IN THIS AREA

DO NOT WRITE IN THIS AREA

DO NOT WRITE IN THIS AREA

22 (a) Find the Highest Common Factor (HCF) of 60 and 84

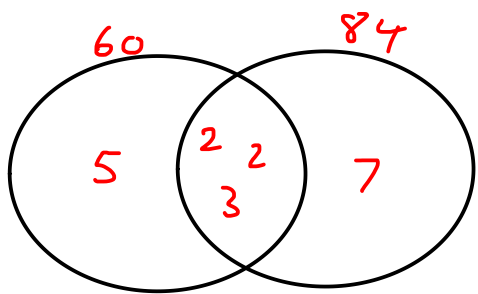
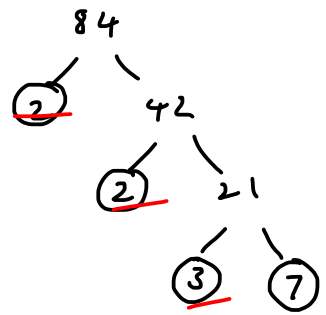
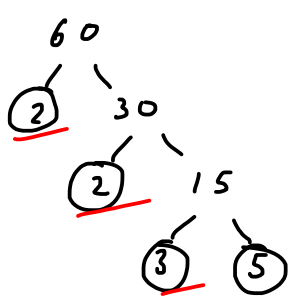

$2 \times 2 \times 3 = 12$

..... 12
(2)

(b) Find the Lowest Common Multiple (LCM) of 24 and 40

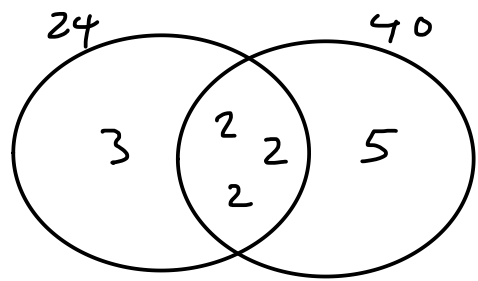
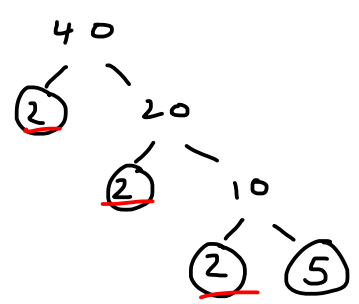
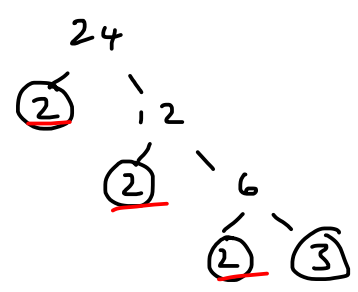

$24 \times 5 = 120$

..... 120
(2)

(Total for Question 22 is 4 marks)



23 Sam drives his car on a journey.

Here is the travel graph for the first 15 minutes of his journey.

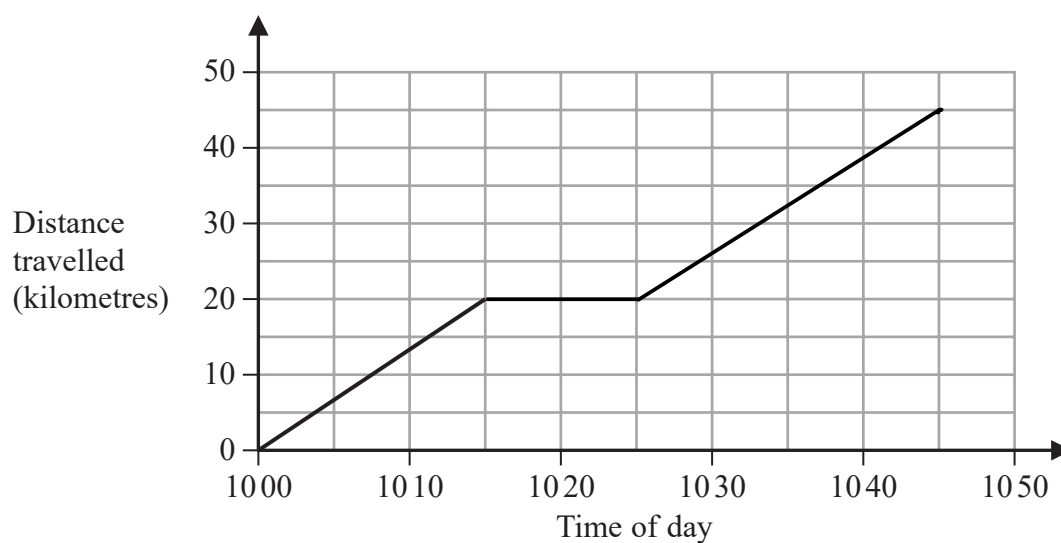

(a) Work out Sam's speed, in km/h, for the first 15 minutes of his journey.

$$20 \text{ km in } 15 \text{ mins}$$

$$\times 4 \qquad \qquad \times 4$$

$$80 \text{ km in } 60 \text{ mins}$$

$$\dots\dots\dots 80 \text{ km/h}$$

(2)

At 1015 Sam stops for 10 minutes and then drives for 20 minutes at a speed of 75 km/h.

(b) On the grid, complete the travel graph for Sam's journey.

$$75 \text{ km in } 60 \text{ mins}$$

$$\div 3 \qquad \qquad \div 3$$

$$25 \text{ km in } 20 \text{ mins}$$

(3)

(Total for Question 23 is 5 marks)



24 (a) Complete the table of values for $y = x^2 - 2x + 2$

x	-2	-1	0	1	2	3	4
y	10	5	2	1	2	5	10

(2)

(b) On the grid, draw the graph of $y = x^2 - 2x + 2$ for values of x from -2 to 4

(2)

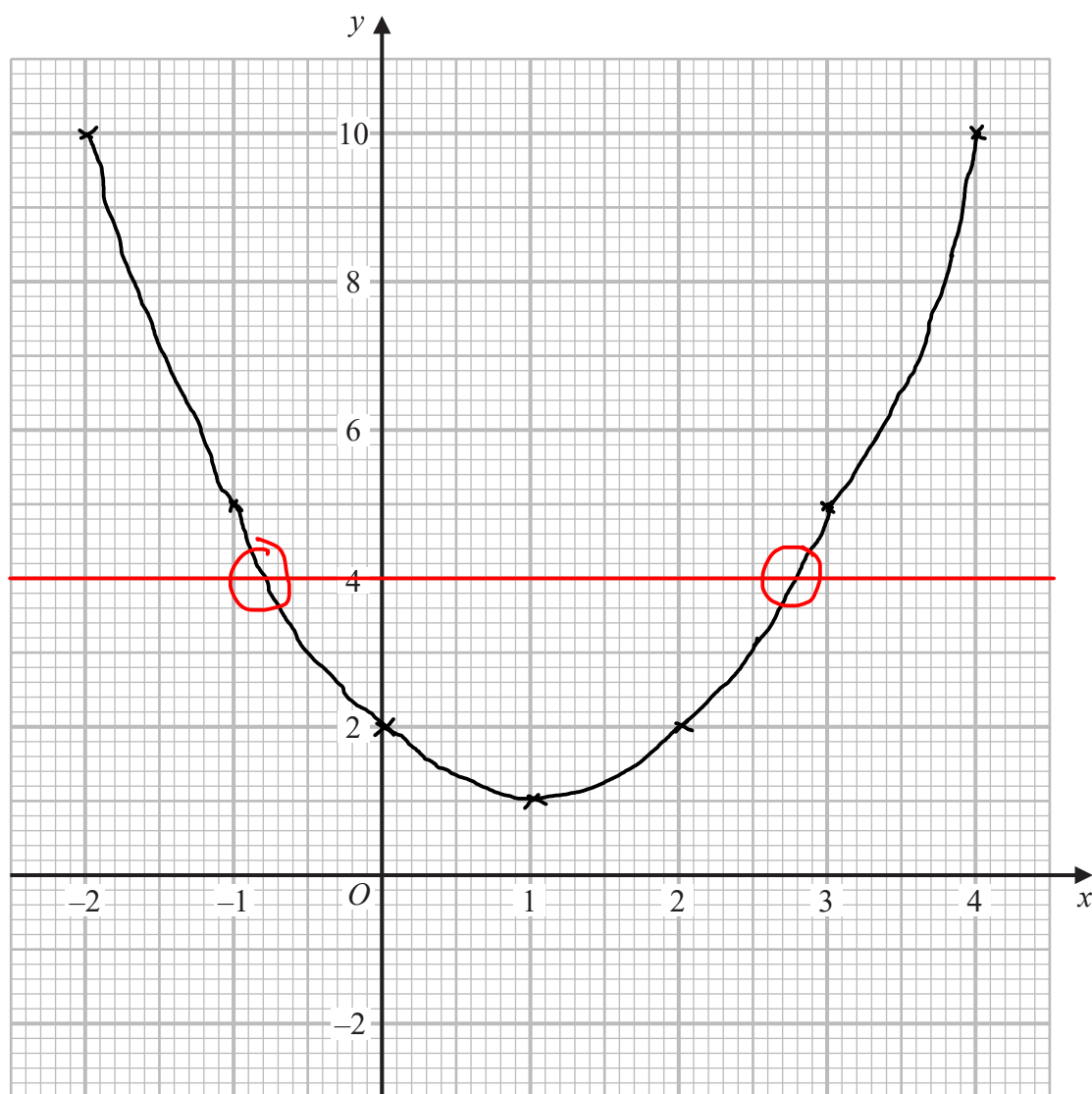

(c) Use your graph to find estimates of the solutions of the equation $x^2 - 2x + 2 = 4$

$$x = -0.8 \text{ or } x = 2.8$$

$$-0.65 \text{ to } -0.8 \quad 2.65 \text{ to } 2.8$$

(Total for Question 24 is 6 marks)



25 Here is a right-angled triangle.

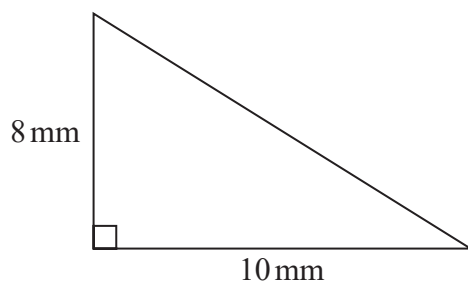

The shaded shape below is made from two of these triangles.

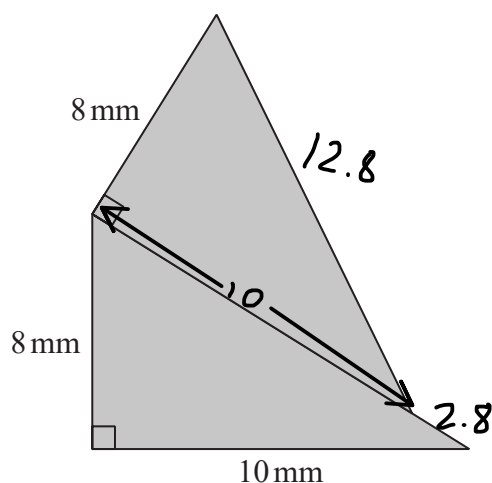

Work out the perimeter of the shaded shape.
Give your answer correct to 3 significant figures.

$$\begin{aligned} 8^2 + 10^2 &= h^2 \\ 164 &= h^2 \\ h &= \sqrt{164} \\ &= 12.8 \text{ mm} \end{aligned}$$

$$10 + 8 + 8 + 12.8 + 2.8 = 41.6 \text{ mm}$$

..... 41.6 mm

(Total for Question 25 is 4 marks)



SOH CAH TOA

26 ABC is a right-angled triangle.

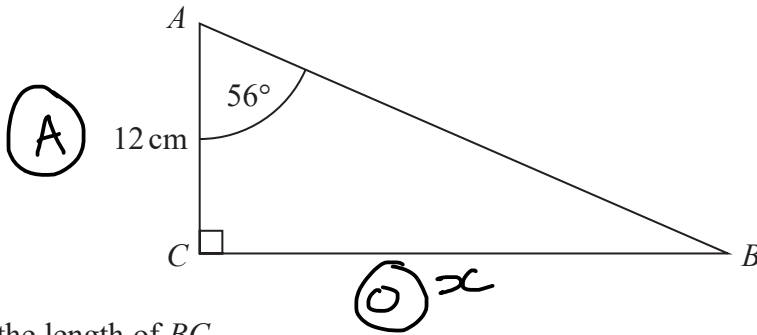

- (a) Work out the length of BC .
Give your answer correct to 1 decimal place.

$$\tan \theta = \frac{O}{A}$$

$$\tan(56) = \frac{x}{12}$$

$$x = 12 \tan(56)$$

17.8

cm

(2)

PQR is a right-angled triangle.

SOH CAH TOA

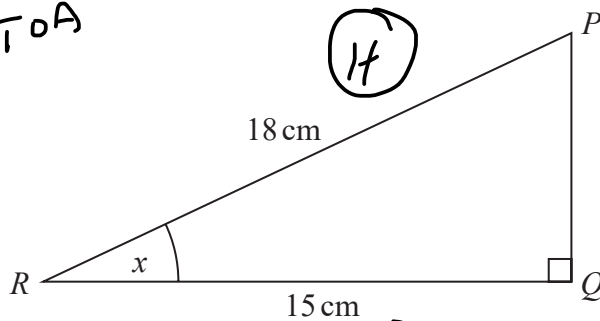

- (b) Work out the size of the angle marked x .
Give your answer correct to 1 decimal place.

$$\cos \theta = \frac{A}{H}$$

$$\cos x = \frac{15}{18}$$

$$x = \cos^{-1}\left(\frac{15}{18}\right)$$

33.6

°

(2)

(Total for Question 26 is 4 marks)



27 Solve $x^2 - 7x - 18 = 0$

$$(x - 9)(x + 2) = 0$$

$$x = 9 \quad x = -2$$

$$x = 9, x = -2$$

(Total for Question 27 is 3 marks)

28 In a sale, the normal price of a boat is reduced by 15%
The sale price of the boat is £272 000

Work out the normal price of the boat.

$$85\% \text{ of original price} = 272000$$

$$0.85x = 272000$$

$$x = \frac{272000}{0.85}$$

$$= 320000$$

$$£ 320 000$$

(Total for Question 28 is 2 marks)

TOTAL FOR PAPER IS 80 MARKS

DO NOT WRITE IN THIS AREA

DO NOT WRITE IN THIS AREA

DO NOT WRITE IN THIS AREA

