

Write your name here

Surname

Other names

Pearson
Edexcel GCSE

Centre Number

--	--	--	--	--

Candidate Number

--	--	--	--

Mathematics A

Paper 1 (Non-Calculator)

Higher Tier

Wednesday 5 November 2014 – Morning
Time: 1 hour 45 minutes

Paper Reference
1MA0/1H

You must have: Ruler graduated in centimetres and millimetres, protractor, pair of compasses, pen, HB pencil, eraser. Tracing paper may be used.

Total Marks



Instructions

- Use **black** ink or ball-point pen.
- **Fill in the boxes** at the top of this page with your name, centre number and candidate number.
- Answer **all** questions.
- Answer the questions in the spaces provided – *there may be more space than you need.*
- **Calculators must not be used.**

Information

- The total mark for this paper is 100
- The marks for **each** question are shown in brackets – *use this as a guide as to how much time to spend on each question.*
- Questions labelled with an **asterisk** (*) are ones where the quality of your written communication will be assessed.

Advice

- Read each question carefully before you start to answer it.
- Keep an eye on the time.
- Try to answer every question.
- Check your answers if you have time at the end.

Turn over ►

P44585A

©2014 Pearson Education Ltd.

6/7/6/6/



PEARSON

GCSE Mathematics 1MA0

Formulae: Higher Tier

**You must not write on this formulae page.
Anything you write on this formulae page will gain NO credit.**

Volume of prism = area of cross section \times length

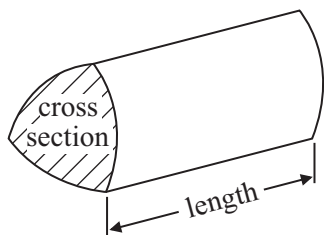

Area of trapezium = $\frac{1}{2} (a + b)h$

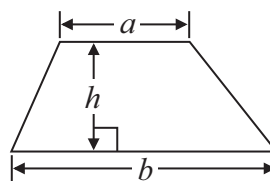

Volume of sphere = $\frac{4}{3} \pi r^3$

Surface area of sphere = $4\pi r^2$

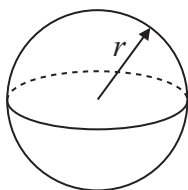

Volume of cone = $\frac{1}{3} \pi r^2 h$

Curved surface area of cone = $\pi r l$

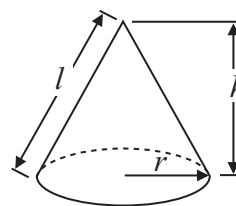

In any triangle ABC

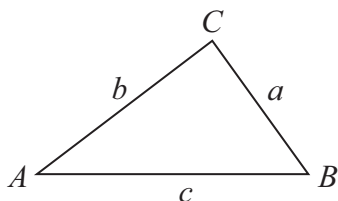

The Quadratic Equation

The solutions of $ax^2 + bx + c = 0$
where $a \neq 0$, are given by

$$x = \frac{-b \pm \sqrt{b^2 - 4ac}}{2a}$$

Sine Rule $\frac{a}{\sin A} = \frac{b}{\sin B} = \frac{c}{\sin C}$

Cosine Rule $a^2 = b^2 + c^2 - 2bc \cos A$

Area of triangle = $\frac{1}{2} ab \sin C$



Answer ALL questions.

Write your answers in the spaces provided.

You must write down all stages in your working.

You must NOT use a calculator.

1 Using the information that

$$6.7 \times 52 = 348.4$$

find the value of

(i) 6.7×520

.....

(ii) 67×0.52

.....

(iii) $3484 \div 5.2$

.....

(Total for Question 1 is 3 marks)

***2** Karen got 32 out of 80 in a maths test.
She got 38% in an English test.

Karen wants to know if she got a higher percentage in maths or in English.

Did Karen get a higher percentage in maths or in English?

(Total for Question 2 is 2 marks)



3 Here are the heights, in cm, of 18 children.

98	90	84	102	115	91
88	91	108	110	97	93
90	89	103	95	92	106

Show this information in an ordered stem and leaf diagram.



(Total for Question 3 is 3 marks)



4 Kalinda buys x packs of currant buns and y boxes of iced buns.

There are 6 currant buns in a pack of currant buns.

There are 8 iced buns in a box of iced buns.

Kalinda buys a total of T buns.

Write down a formula for T in terms of x and y .

.....
(Total for Question 4 is 3 marks)

5 (a) Solve the inequality $6y + 5 > 8$

.....
(2)

(b) Here is an inequality, in x , shown on a number line.

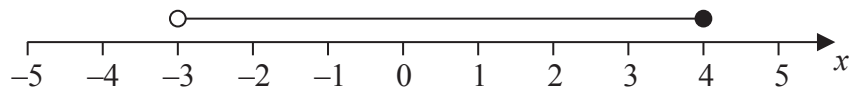

Write down the inequality.

.....
(2)

(Total for Question 5 is 4 marks)



*6 Steve wants to put a hedge along one side of his garden.

He needs to buy 27 plants for the hedge.

Each plant costs £5.54

Steve has £150 to spend on plants for the hedge.

Does Steve have enough money to buy all the plants he needs?

(Total for Question 6 is 4 marks)



7 The diagram shows the plan of a floor.

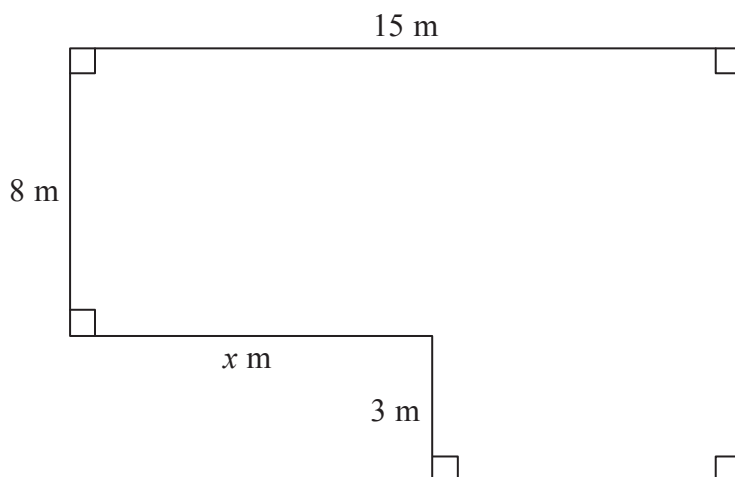

Diagram **NOT** accurately drawn

The area of the floor is 138 m^2 .

Work out the value of x .

.....
(Total for Question 7 is 4 marks)



*8

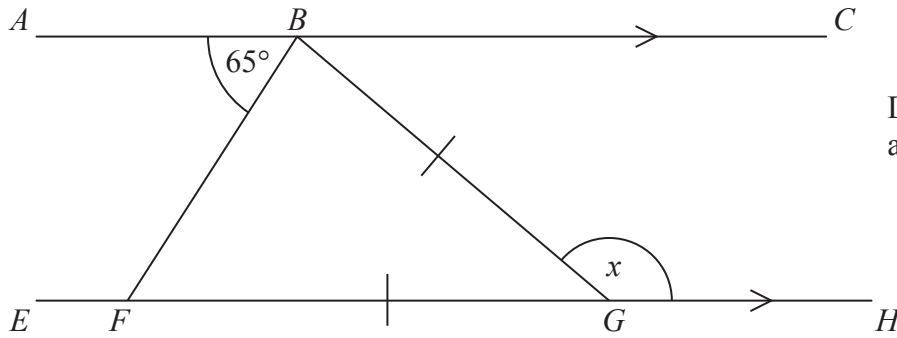

Diagram **NOT**
accurately drawn

ABC is parallel to $EFGH$.

$GB = GF$

Angle $ABF = 65^\circ$

Work out the size of the angle marked x .

Give reasons for your answer.

(Total for Question 8 is 4 marks)



9 Jack wants to find out how far people live from their nearest supermarket.

He uses this question on a questionnaire.

How far do you live from your nearest supermarket?			
<input type="checkbox"/>	<input type="checkbox"/>	<input type="checkbox"/>	<input type="checkbox"/>
0 to 2	2 to 3	3 to 4	5 to 6

(a) Write down **two** things wrong with this question.

1

2

(2)

Jack also wants to find out how often people go shopping.

(b) Write a question Jack could use on his questionnaire to find out how often people go shopping.

(2)

(Total for Question 9 is 4 marks)



- 10 Use ruler and compasses to **construct** the perpendicular from point C to the line AB .
You must show all your construction lines.

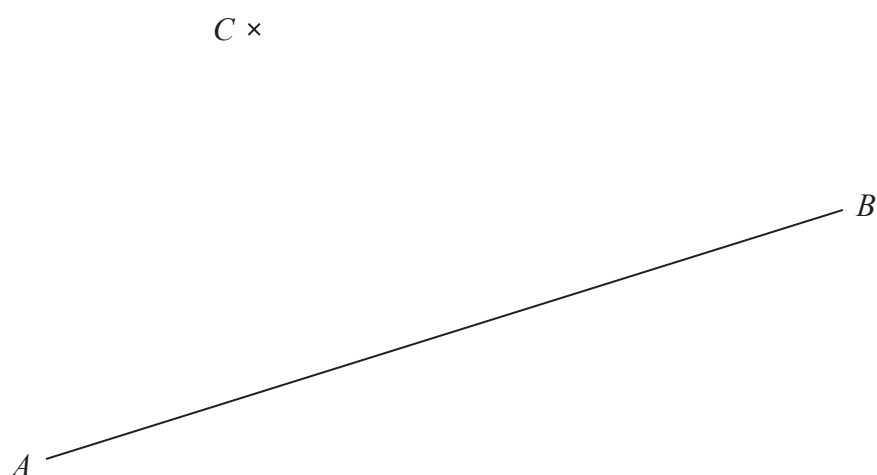

(Total for Question 10 is 2 marks)



11 Ria is going to buy a caravan.
The total cost of the caravan is £7000 **plus** VAT at 20%.

Ria pays a deposit of £3000
She pays the rest of the total cost in 6 equal monthly payments.

Work out the amount of each monthly payment.

£.....

(Total for Question 11 is 4 marks)



12 (a) Factorise $3e^2 + 5e$

.....
(1)

(b) Solve $7(k - 3) = 3k - 5$

$k =$
(3)

(c) Expand and simplify $(2x + 3)(x - 8)$

.....
(2)

(d) Solve $\frac{7 - 3f}{4} = 2$

$f =$
(3)

(Total for Question 12 is 9 marks)



13 (a) Express 180 as a product of its prime factors.

.....
(3)

Martin thinks of two numbers.

He says,

“The Highest Common Factor (HCF) of my two numbers is 6

The Lowest Common Multiple (LCM) of my two numbers is a multiple of 15”

(b) Write down **two** possible numbers that Martin is thinking of.

.....
(2)

(Total for Question 13 is 5 marks)



- 14 Suha has a full 600 ml bottle of wallpaper remover.
She is going to mix some of the wallpaper remover with water.

Here is the information on the label of the bottle.

Wallpaper remover
600 ml

Mix $\frac{1}{4}$ of the wallpaper remover
with 4500 ml of water

Suha is going to use 750 ml of water.

How many millilitres of wallpaper remover should Suha use?
You must show your working.

..... ml

(Total for Question 14 is 4 marks)



15 The students in a class kept a record of the amount of time, in minutes, they spent doing homework last week.

The table shows information about the amount of time the girls spent doing homework last week.

	Minutes
Least amount of time	60
Range	230
Median	170
Lower quartile	100
Upper quartile	220

(a) On the grid, draw a box plot for the information in the table.

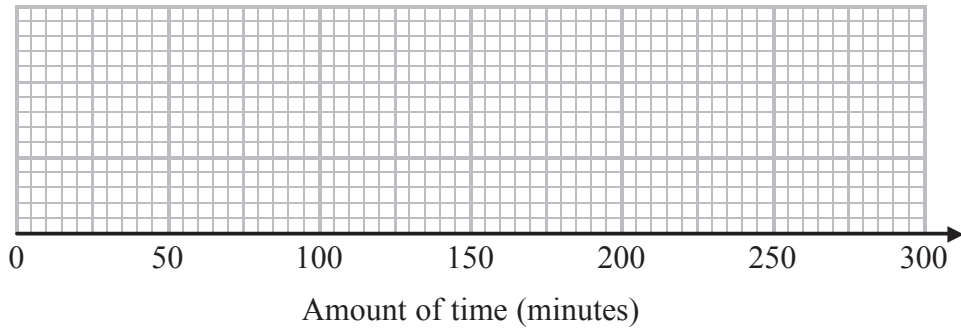

(2)

The box plot below shows information about the amount of time the boys spent doing homework last week.

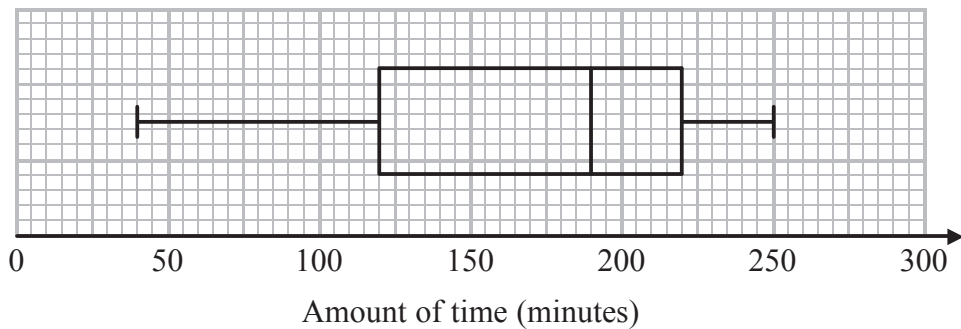

*(b) Compare the amount of time the girls spent doing homework with the amount of time the boys spent doing homework.

.....

.....

.....

.....

(2)

(Total for Question 15 is 4 marks)



16 There are 200 workers at a factory.

The cumulative frequency table gives information about their ages.

Age (a years)	Cumulative frequency
$0 < a \leq 20$	25
$0 < a \leq 30$	70
$0 < a \leq 40$	138
$0 < a \leq 50$	175
$0 < a \leq 60$	186
$0 < a \leq 70$	194
$0 < a \leq 80$	200

(a) On the grid opposite, draw a cumulative frequency graph for this information.

(2)

(b) Graham says,

“10% of workers at the factory are older than 65”

Is Graham correct?

You must show how you get your answer.

.....

.....

.....

.....

(2)



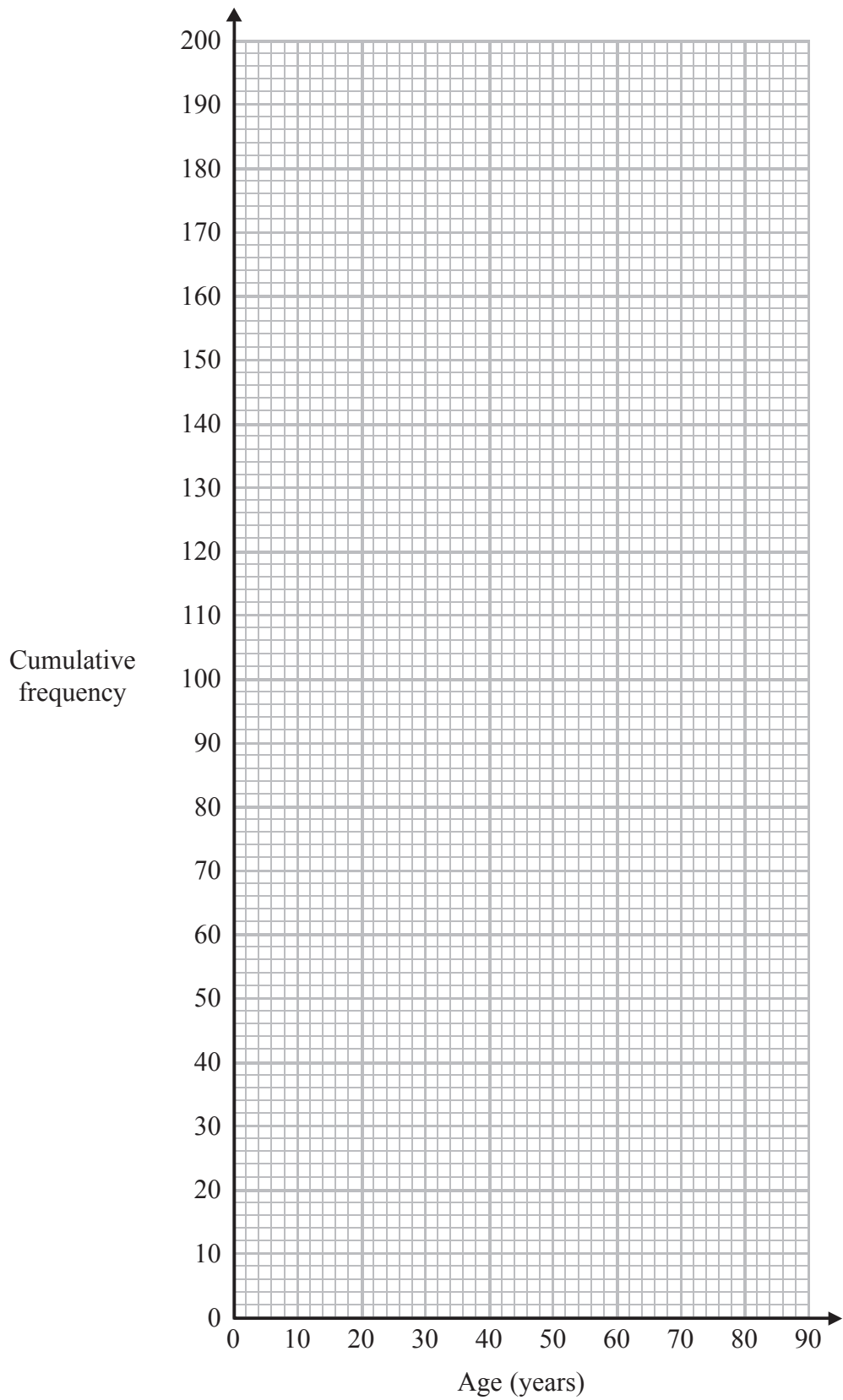

(Total for Question 16 is 4 marks)



P 4 4 5 8 5 A 0 1 7 2 8

Diagram **NOT**
accurately drawn

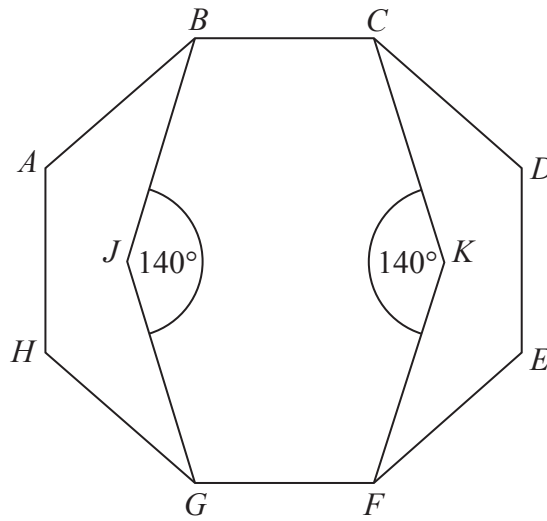

ABCDEFGH is a regular octagon.
BCKFGJ is a hexagon.

JK is a line of symmetry of the hexagon.
Angle *BJG* = angle *CKF* = 140°

Work out the size of angle *KFE*.
You must show all your working.

.....^o

(Total for Question 17 is 4 marks)



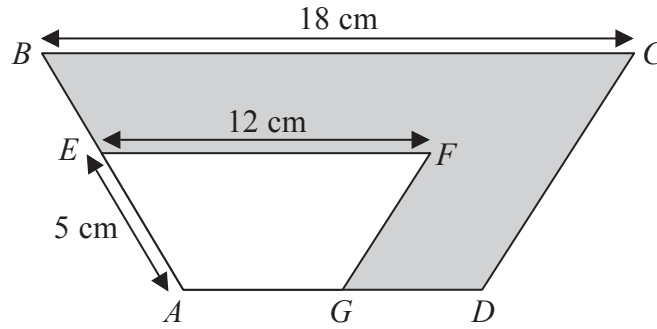

Diagram **NOT** accurately drawn

$ABCD$ and $AEFG$ are mathematically similar trapeziums.

- $AE = 5 \text{ cm}$
- $EF = 12 \text{ cm}$
- $BC = 18 \text{ cm}$

(a) Work out the length of AB .

..... cm

(2)

Trapezium $AEFG$ has an area of 36 cm^2 .

(b) Work out the area of the shaded region.

..... cm^2

(3)

(Total for Question 18 is 5 marks)



19 (a) Complete the table of values for $y = \frac{4}{x}$

x	0.5	1	2	4	5	8
y		4	2			

(2)

(b) On the grid, draw the graph of $y = \frac{4}{x}$ for $0.5 \leq x \leq 8$

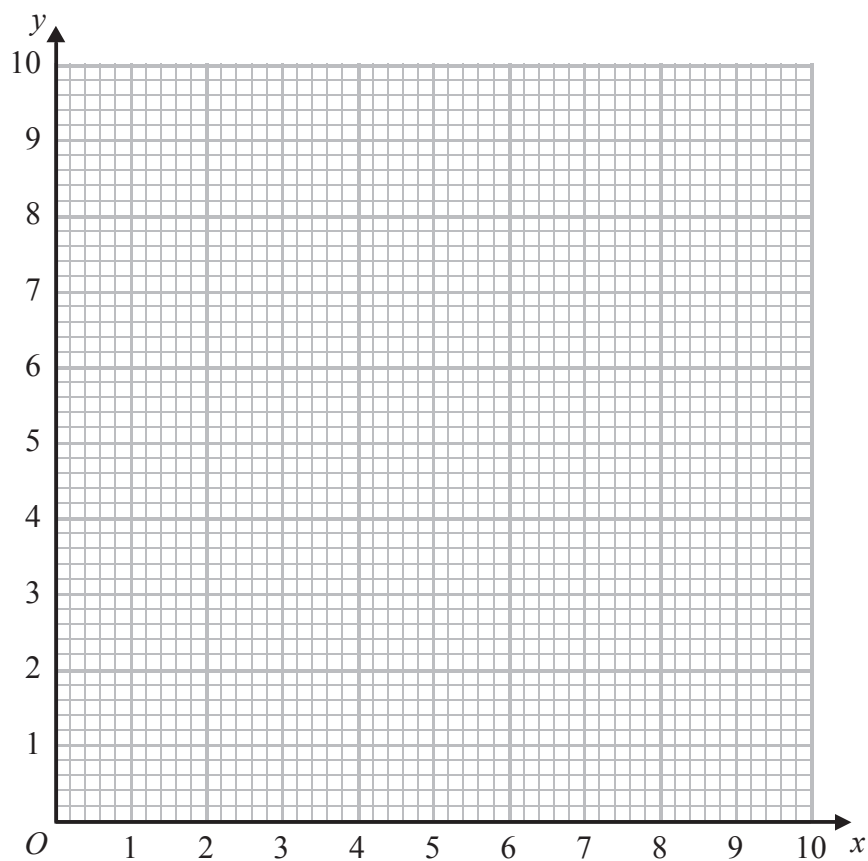

(2)

(Total for Question 19 is 4 marks)



20 The diagram shows a solid shape.

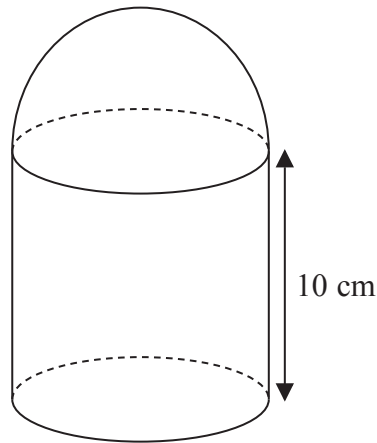

Diagram **NOT**
accurately drawn

The solid shape is made from a cylinder and a hemisphere.
The radius of the cylinder is equal to the radius of the hemisphere.

The cylinder has a height of 10 cm.
The curved surface area of the hemisphere is $32\pi \text{ cm}^2$.

Work out the total surface area of the solid shape.
Give your answer in terms of π .

..... cm^2

(Total for Question 20 is 5 marks)



21 Expand $(1 + \sqrt{2})(3 - \sqrt{2})$

Give your answer in the form $a + b\sqrt{2}$ where a and b are integers.

.....
(Total for Question 21 is 2 marks)



22 (a) Simplify fully $(3e)^0$

.....
(1)

(b) Simplify fully $\left(\frac{64x^6}{25y^2}\right)^{-\frac{1}{2}}$

.....
(2)

(c) Write $\frac{5}{x-3} - \frac{4}{x+3}$ as a single fraction in its simplest form.

.....
(3)

(Total for Question 22 is 6 marks)



23 Paul has 8 cards.
There is a number on each card.



Paul takes at random 3 of the cards.
He adds together the 3 numbers on the cards to get a total T .

Work out the probability that T is an odd number.

.....
(Total for Question 23 is 4 marks)



*24 A is the point with coordinates $(1, 3)$
 B is the point with coordinates $(4, -1)$
The straight line L goes through both A and B .

Is the line with equation $2y = 3x - 4$ perpendicular to line L ?
You must show how you got your answer.

(Total for Question 24 is 4 marks)



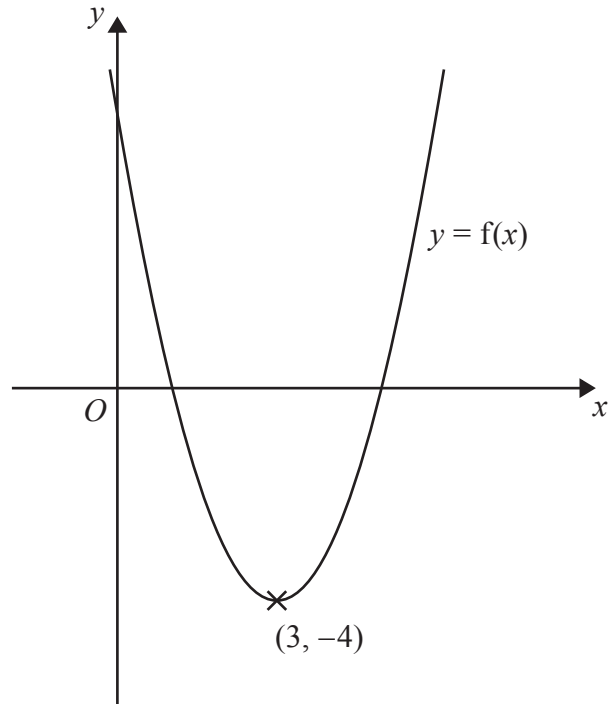

The diagram shows part of the curve with equation $y = f(x)$.
The coordinates of the minimum point of this curve are $(3, -4)$

Write down the coordinates of the minimum point of the curve with equation

(i) $y = f(x) + 3$

(.....,))

(ii) $y = f(2x)$

(.....,))

(iii) $y = f(-x)$

(.....,))

(Total for Question 25 is 3 marks)

TOTAL FOR PAPER IS 100 MARKS



BLANK PAGE



BLANK PAGE

