

GCSE Mathematics Specification (8300/1H)

H

Paper 1 Higher tier

Date

Morning

1 hour 30 minutes

Materials

For this paper you must have:

- mathematical instruments

You must **not** use a calculator



Instructions

- Use black ink or black ball-point pen. Draw diagrams in pencil.
- Fill in the boxes at the bottom of this page.
- Answer **all** questions.
- You must answer the questions in the spaces provided. Do not write outside the box around each page or on blank pages.
- Do all rough work in this book.
- In all calculations, show clearly how you work out your answer.

Information

- The marks for questions are shown in brackets.
- The maximum mark for this paper is 80.
- You may ask for more answer paper, graph paper and tracing paper. These must be tagged securely to this answer book.

Please write clearly, in block capitals, to allow character computer recognition.

Centre number

Candidate number

Surname

Forename(s)

Candidate signature _____

Answer **all** questions in the spaces provided.

- 1** Circle the calculation that increases 400 by 7% **[1 mark]**

400×0.07

400×0.7

400×1.07

400×1.7

- 2** Simplify $3^4 \times 3^4$
Circle the answer. **[1 mark]**

3^8

9^8

3^{16}

9^{16}

- 3** Circle the area that is the same as 5.5 m^2 **[1 mark]**

550 cm^2

$5\,500 \text{ cm}^2$

$55\,000 \text{ cm}^2$

$5\,500\,000 \text{ cm}^2$

4 One of these graphs is a sketch of $y = 1 - 2x$

Which one?

Circle the correct letter.

[1 mark]

A

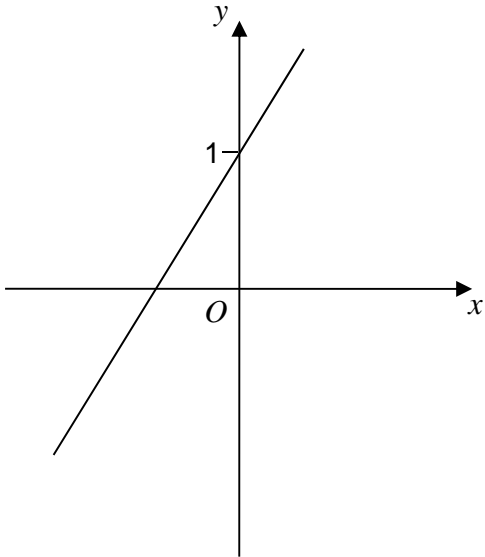

B

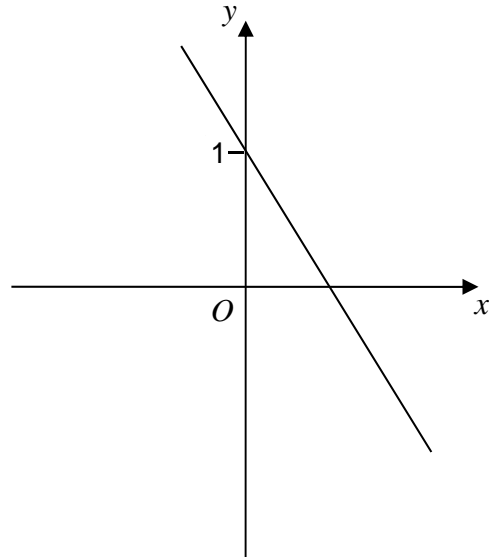

C

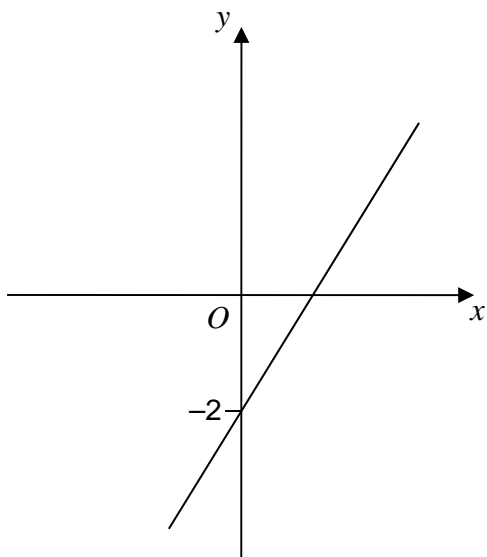

D

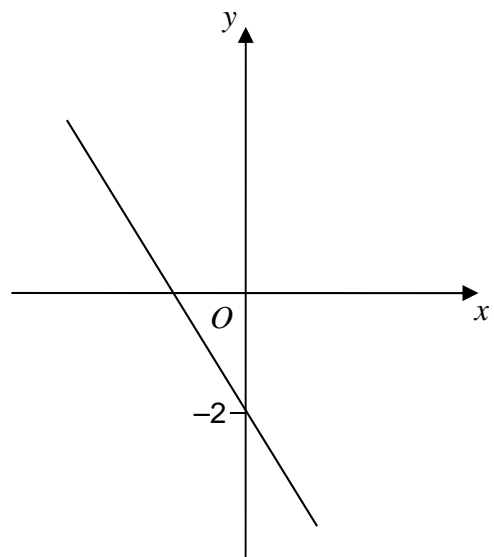

- 5 The scatter graph shows the age and the price of 18 cars.
The cars are all the same make and model.

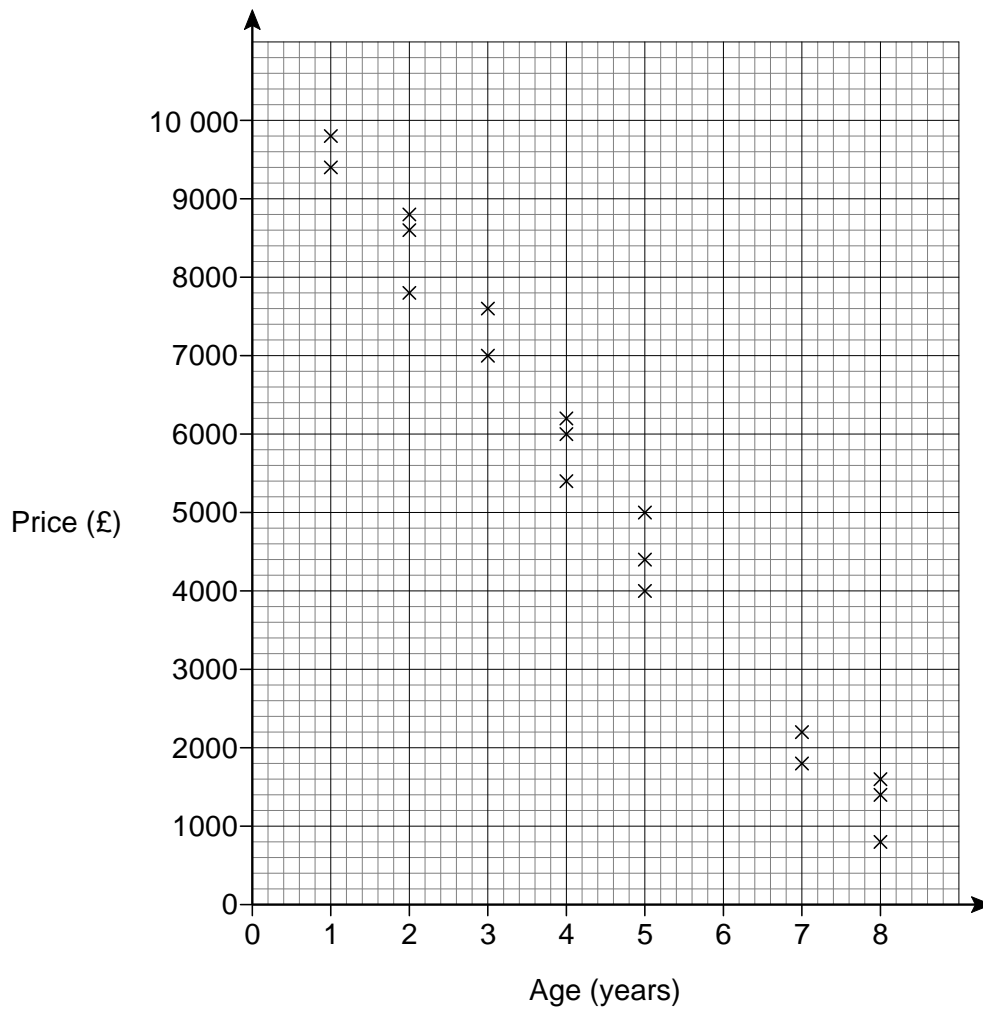

Use a line of best fit to estimate the price of a 6-year old car.

[2 marks]

Answer £ _____

- 6 Kelly is trying to work out the two values of w for which $3w - w^3 = 2$
Her values are 1 and -1

Are her values correct?

You **must** show your working.

[2 marks]

- 7 Work out $2\frac{3}{4} \times 1\frac{5}{7}$

Give your answer as a mixed number in its simplest form.

[3 marks]

Answer _____

8 Solve $5x - 2 > 3x + 11$

[2 marks]

Answer _____

9 The n th term of a sequence is $2n + 1$
The n th term of a different sequence is $3n - 1$

Work out the **three** numbers that are

in both sequences

and

between 20 and 40

[3 marks]

Answer _____, _____, _____

- 10** White paint costs £2.80 per litre.
Blue paint costs £3.50 per litre.
White paint and blue paint are mixed in the ratio 3 : 2
Work out the cost of 18 litres of the mixture.

[4 marks]

Answer £ _____

Turn over for the next question

- 11 Students in a class took a spelling test.
The diagram shows information about the scores.

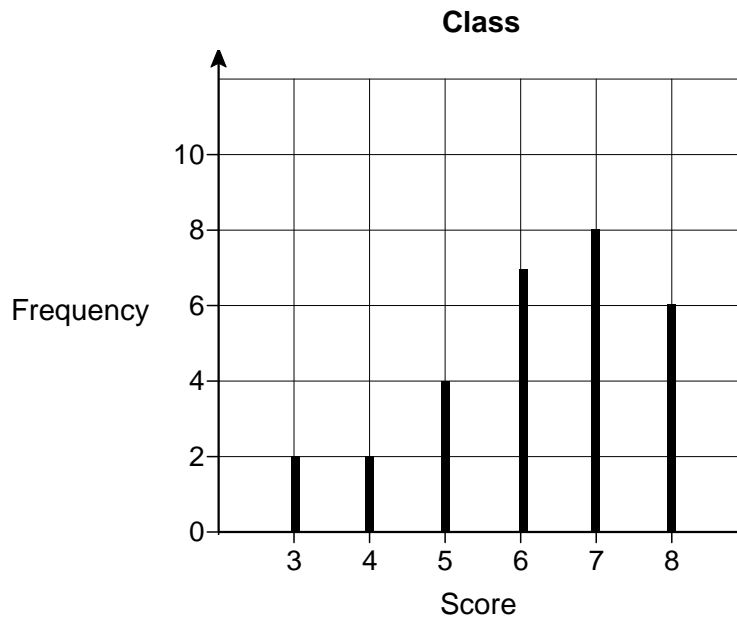

Lucy is one of the 29 students in the class.
Her score was the same as the **median** score for her class.

Work out her score.

[2 marks]

Answer _____

12

 $ABCH$ is a square. $HCFG$ is a rectangle. $CDEF$ is a square.

They are joined to make an L-shape.

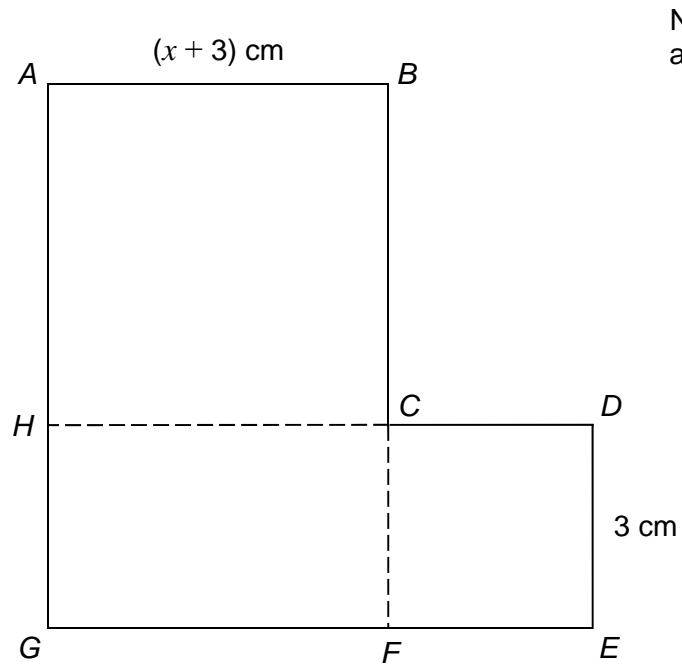
Not drawn
accuratelyShow that the total area of the L-shape, in cm^2 , is $x^2 + 9x + 27$ **[4 marks]**

Turn over ▶

13 Here are sketches of four triangles.

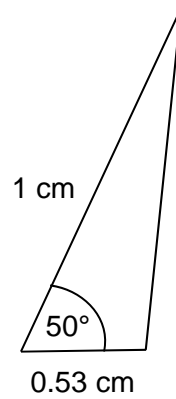
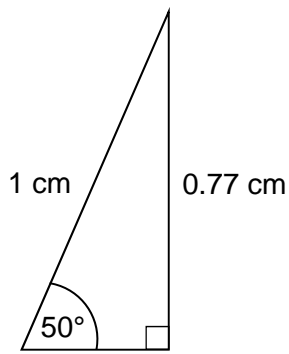

Not drawn accurately

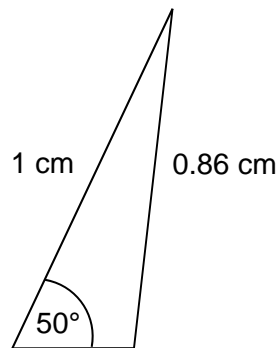
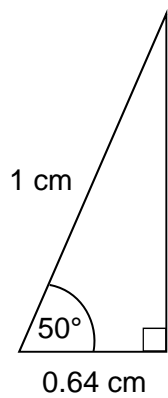

In each triangle

the longest side is **exactly** 1 cm

the other length is given to 2 decimal places.

13 (a) Circle the value of $\cos 50^\circ$ to 2 decimal places.

[1 mark]

0.77

0.53

0.64

0.86

- 13 (b)** Work out the value of x .
Give your answer to 1 decimal place.

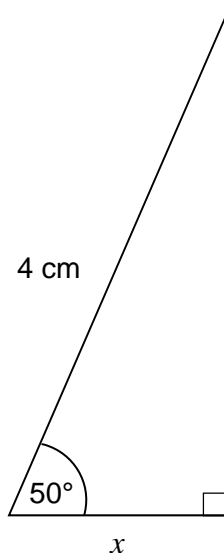

Not drawn
accurately

[2 marks]

Answer _____ cm

Turn over for the next question

- 14** A prime number between 300 and 450 is chosen at random.
The table shows the probability that the number lies in different ranges.

Prime number, n	Probability
$300 \leq n < 330$	0.16
$330 \leq n < 360$	0.24
$360 \leq n < 390$	x
$390 \leq n < 420$	0.16
$420 \leq n < 450$	0.24

- 14 (a)** Work out the value of x .

[2 marks]

Answer _____

- 14 (b)** Work out the probability that the prime number is greater than 390

[1 mark]

Answer _____

14 (c) There are four prime numbers between 300 and 330

How many prime numbers are there between 300 and 450?

[2 marks]

Answer _____

15 $a \times 10^4 + a \times 10^2 = 24\,240$ where a is a number.

Work out $a \times 10^4 - a \times 10^2$

Give your answer in standard form.

[2 marks]

Answer _____

- 16 AB , CD and YZ are straight lines.
All angles are in degrees.

Not drawn
accurately

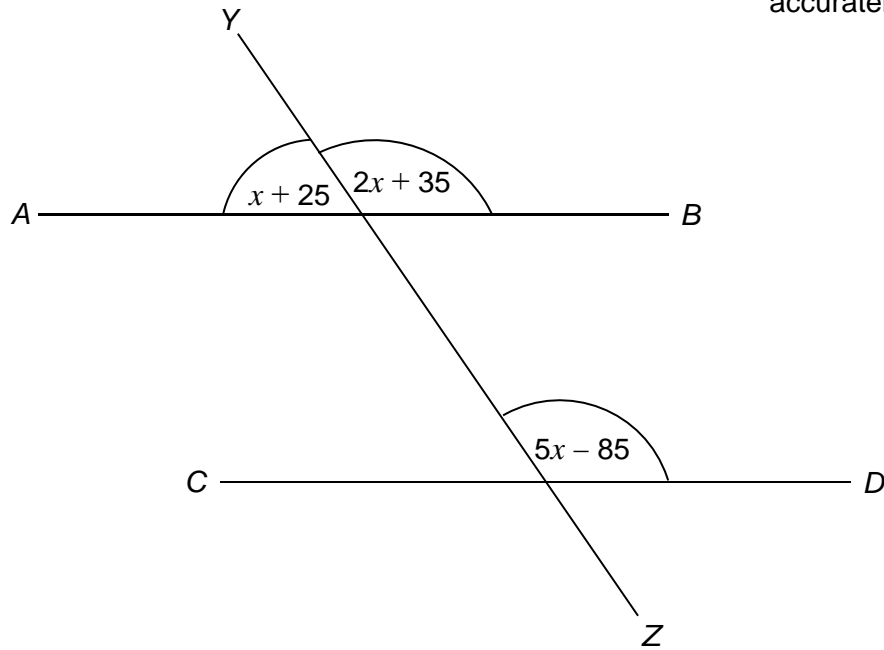

Show that AB is parallel to CD .

[4 marks]

17 To complete a task in 15 days a company needs
4 people each working for 8 hours per day.

The company decides to have
5 people each working for 6 hours per day.

Assume that each person works at the same rate.

17 (a) How many days will the task take to complete?
You **must** show your working.

[3 marks]

Answer _____

17 (b) Comment on how the assumption affects your answer to part (a).

[1 mark]

18 In this question all dimensions are in centimetres.

A solid has uniform cross section.

The cross section is a rectangle and a semicircle joined together.

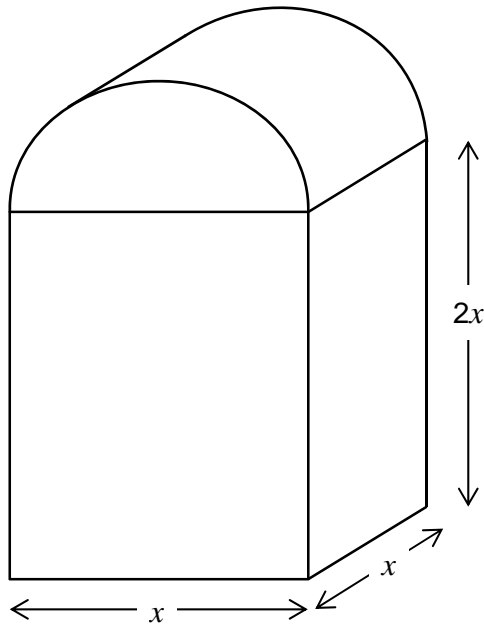

Work out an expression, in cm^3 , for the **total** volume of the solid.

Write your expression in the form $ax^3 + \frac{1}{b}\pi x^3$ where a and b are integers.

[4 marks]

Answer _____ cm^3

- 19** Show that $12 \cos 30^\circ - 2 \tan 60^\circ$ can be written in the form \sqrt{k} where k is an integer.

[3 marks]

Turn over for the next question

20 On Friday, Greg takes part in a long jump competition.
He has to jump at least 7.5 metres to qualify for the final on Saturday.

- He has up to three jumps to qualify.
- If he jumps at least 7.5 metres he does **not** jump again on Friday.

Each time Greg jumps, the probability he jumps at least 7.5 metres is 0.8
Assume each jump is independent.

20 (a) Complete the tree diagram.

[2 marks]

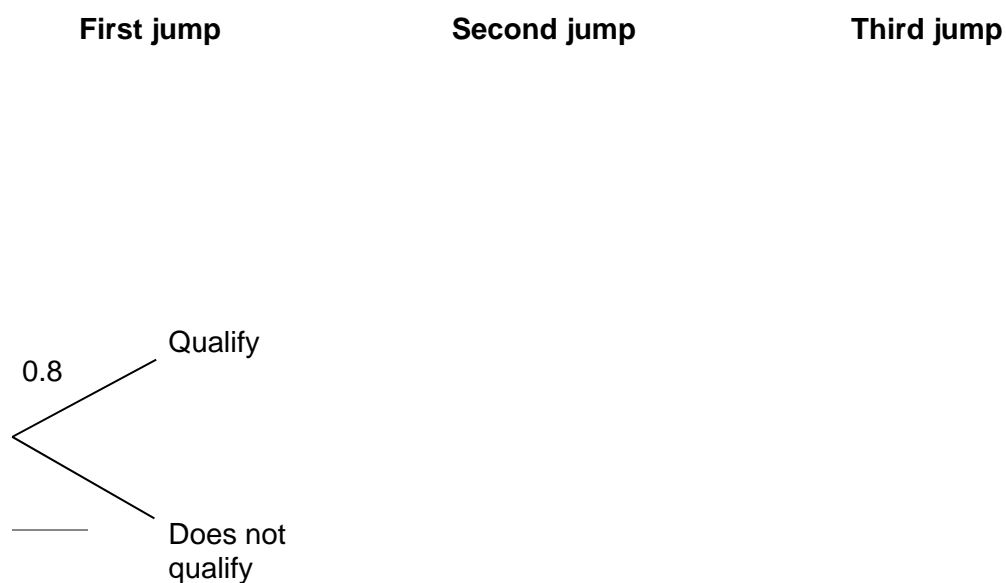

20 (b) Work out the probability that he does **not** need the third jump to qualify.

[2 marks]

Answer _____

21

A , B and C are points on a circle.

- BC bisects angle ABQ .
- PBQ is a tangent to the circle.

Not drawn
accurately

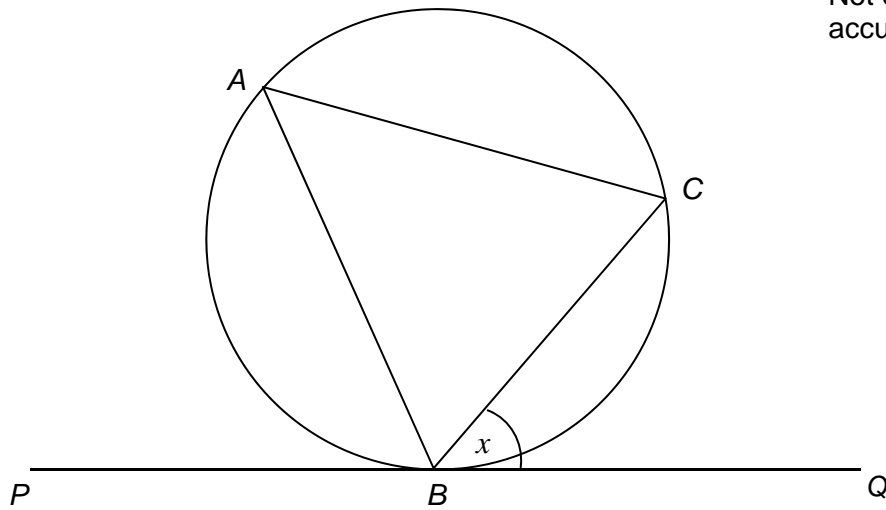

Angle $CBQ = x$

Prove that $AC = BC$

[3 marks]

Turn over for the next question

22 Steph is solving a problem.

Cube A has a surface area of 150 cm^2

Cube B has sides half the length of cube A

What is the volume of cube B?

To solve this problem, Steph decides to

- halve the surface area
- calculate the square root of the answer
- then divide by 6
- then cube this answer to work out the volume.

Evaluate Steph's method.

[2 marks]

23 Square $OABC$ is drawn on a centimetre grid.

O is $(0, 0)$ A is $(2, 0)$ B is $(2, 2)$ C is $(0, 2)$

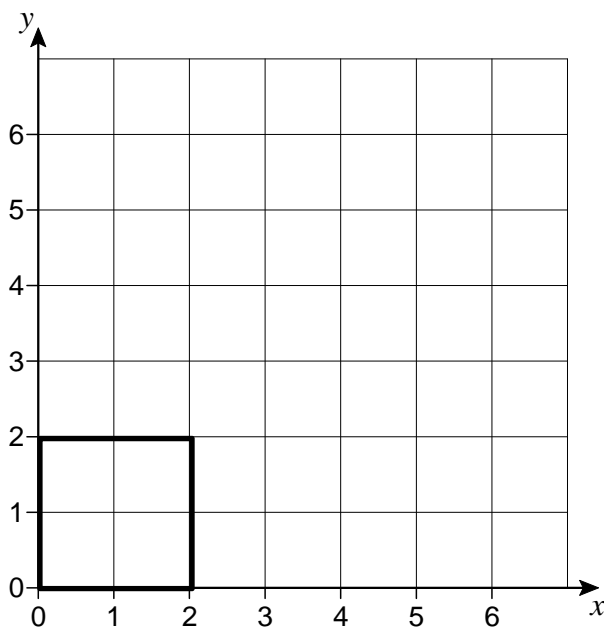

23 (a) $OABC$ is translated by the vector $\begin{pmatrix} 3 \\ 1 \end{pmatrix}$

Circle the number of invariant points on the perimeter of the square.

[1 mark]

0 1 2 4

23 (b) $OABC$ is enlarged, scale factor 2, centre $(0, 0)$

Circle the number of invariant points on the perimeter of the square.

[1 mark]

0 1 2 4

23 (c) $OABC$ is reflected in the line $y = x$

Circle the number of invariant points on the perimeter of the square.

[1 mark]

0 1 2 4

24 Here is the velocity-time graph of a car for 50 seconds.

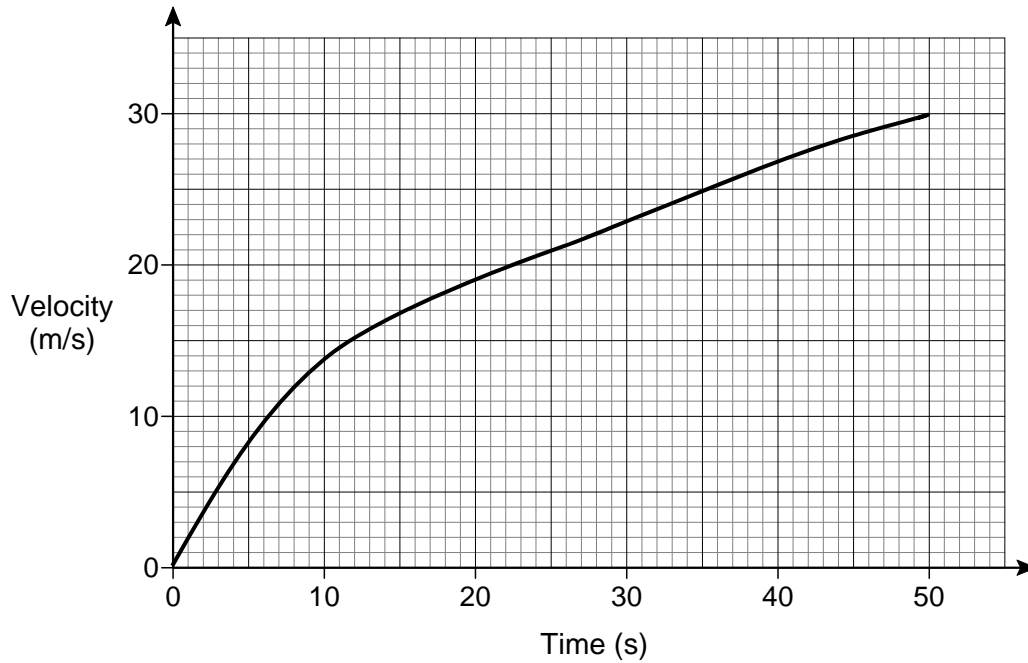

24 (a) Work out the average acceleration during the 50 seconds.

Give the units of your answer.

[2 marks]

Answer _____

24 (b) Estimate the time during the 50 seconds when

the instantaneous acceleration = the average acceleration

You **must** show your working on the graph.

[2 marks]

Answer _____ seconds

25

$$f(x) = 2x + c$$

$$g(x) = cx + 5$$

$$fg(x) = 6x + d$$

c and d are constants.

Work out the value of d .

[3 marks]

Answer _____

Turn over for the next question

26 Rationalise the denominator and simplify $\frac{10}{3\sqrt{5}}$

[2 marks]

Answer _____

27 Convert $0.1\dot{7}\dot{2}$ to a fraction in its lowest terms.

[3 marks]

Answer _____

28 The diagram shows the circle $x^2 + y^2 = 10$

P lies on the circle and has x -coordinate 1

The tangent at P intersects the x -axis at Q .

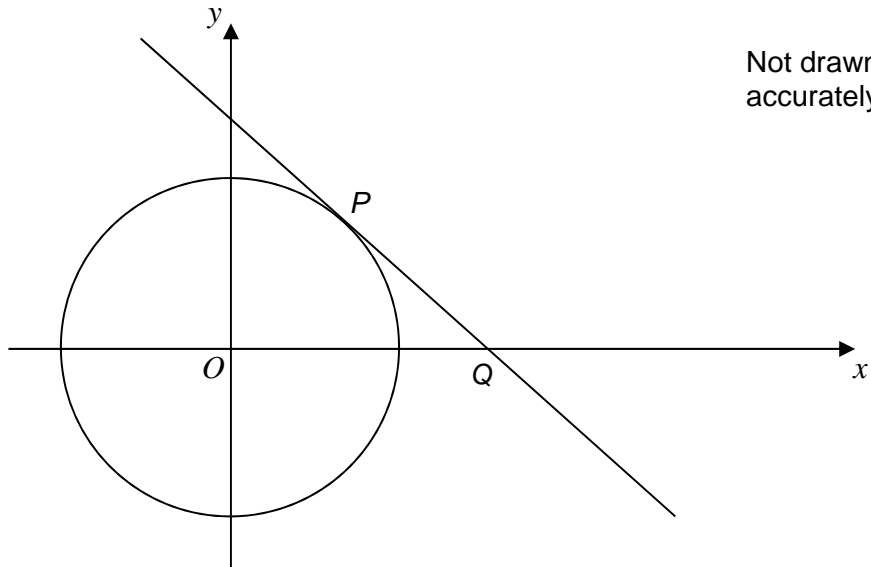

Work out the coordinates of Q .

[5 marks]

Answer (_____ , _____)

END OF QUESTIONS

There are no questions printed on this page

**DO NOT WRITE ON THIS PAGE
ANSWER IN THE SPACES PROVIDED**