

Please check the examination details below before entering your candidate information

Candidate surname

Other names

Centre Number

Candidate Number

Pearson Edexcel
Level 1/Level 2 GCSE (9–1)

--	--	--	--	--

--	--	--	--

Thursday 6 June 2019

Morning (Time: 1 hour 30 minutes)

Paper Reference **1MA1/2H**

Mathematics

Paper 2 (Calculator)

Higher Tier

You must have: Ruler graduated in centimetres and millimetres, protractor, pair of compasses, pen, HB pencil, eraser, calculator. Tracing paper may be used.

Total Marks

Instructions

- Use **black** ink or ball-point pen.
- **Fill in the boxes** at the top of this page with your name, centre number and candidate number.
- Answer **all** questions.
- Answer the questions in the spaces provided – *there may be more space than you need.*
- You must **show all your working**.
- Diagrams are **NOT** accurately drawn, unless otherwise indicated.
- **Calculators may be used.**
- If your calculator does not have a π button, take the value of π to be 3.142 unless the question instructs otherwise.



Information

- The total mark for this paper is 80
- The marks for **each** question are shown in brackets – *use this as a guide as to how much time to spend on each question.*

Advice

- Read each question carefully before you start to answer it.
- Keep an eye on the time.
- Try to answer every question.
- Check your answers if you have time at the end.

Turn over ►

P54214A

©2019 Pearson Education Ltd.

6/6/1/1/1/1/1/



Pearson

Answer ALL questions.

Write your answers in the spaces provided.

You must write down all the stages in your working.

1 (a) Solve $14n > 11n + 6$
 $-11n \quad -11n$

$$3n > 6$$

$$n > 2$$

$$n > 2$$

(2)

(b) On the number line below, show the set of values of x for which $-2 < x + 3 \leq 4$

$$-3 \quad -3 \quad -3$$

$$-5 < x \leq 1$$

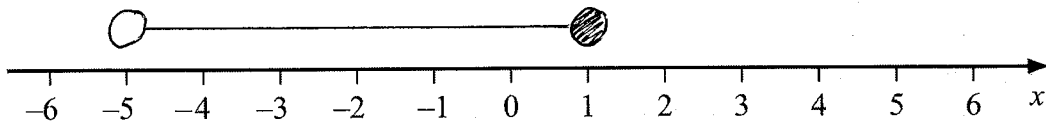

(3)

(Total for Question 1 is 5 marks)



2 On the grid below, draw the graph of $y = 2x - 3$ for values of x from -2 to 4

x	-2	-1	0	1	2	3	4
y	-7	-5	-3	-1	1	3	5

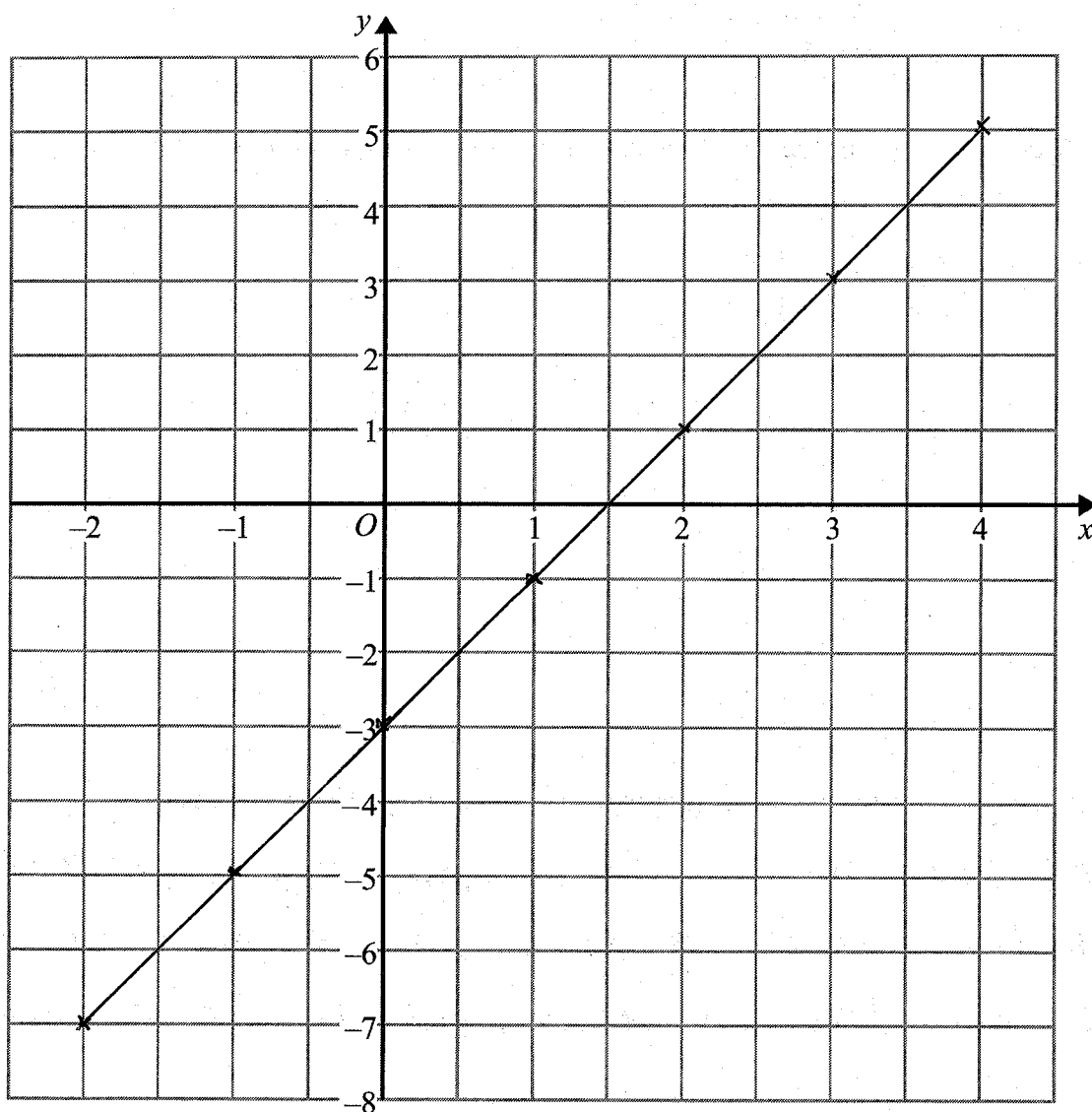

(Total for Question 2 is 3 marks)



3 Hannah is planning a day trip for 195 students.

She asks a sample of 30 students where they want to go.
Each student chooses one place.

The table shows information about her results.

Place	Number of students
Theme Park	10
Theatre	5
Sports Centre	8
Seaside	7

(i) Work out how many of the 195 students you think will want to go to the Theme Park.

$$\frac{10}{30} = \frac{1}{3}$$

$$\frac{1}{3} \text{ of } 195 = \frac{195}{3} = 65$$

65
(2)

(ii) State any assumption you made **and** explain how this may affect your answer.

The students in the sample are representative
of the students going on the trip. If they
are not the answer would not be accurate
(1)

(Total for Question 3 is 3 marks)



- 4 A container is in the shape of a cuboid.

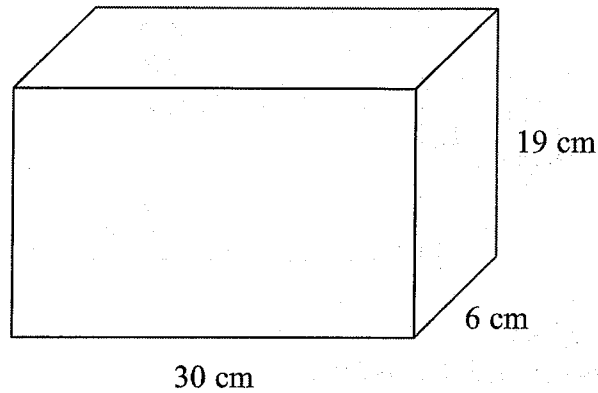

The container is $\frac{2}{3}$ full of water.

A cup holds 275 ml of water.

What is the greatest number of cups that can be completely filled with water from the container?

$$\begin{aligned} \text{volume} &= 30 \times 6 \times 19 \\ &= 3420 \text{ cm}^3 \\ &= 3420 \text{ ml} \end{aligned}$$

$$\begin{aligned} \frac{2}{3} \text{ of } 3420 &= \frac{2}{3} \times 3420 \\ &= 2280 \text{ ml} \end{aligned}$$

$$\frac{2280}{275} = 8.29... \text{ cups}$$

8 cups filled completely

8

(Total for Question 4 is 4 marks)

5 ABC is a right-angled triangle.

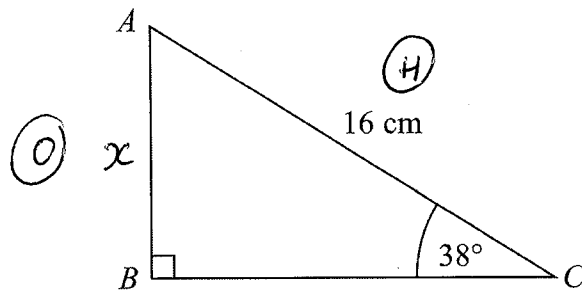

Calculate the length of AB .
Give your answer correct to 2 decimal places.

$$\sin(\theta) = \frac{O}{H}$$

$$\sin(38) = \frac{x}{16}$$

$$\begin{aligned} x &= 16 \sin(38) \\ &= 9.85 \text{ cm (2 dp)} \end{aligned}$$

..... 9.85 cm

(Total for Question 5 is 2 marks)

6 Sally used her calculator to work out the value of a number y .

The answer on her calculator display began

8.3

Complete the error interval for y .

..... 8.3 $\leq y <$ 8.4

(Total for Question 6 is 2 marks)



7 £360 is shared between Abby, Ben, Chloe and Denesh.

The ratio of the amount Abby gets to the amount Ben gets is 2:7

Chloe and Denesh each get 1.5 times the amount Abby gets. $1.5 \times 2 = 3$

Work out the amount of money that Ben gets.

$$A : B : C : D$$
$$2 : 7 : 3 : 3 \quad 15 \text{ PARTS}$$

$$\frac{360}{15} = £24 \text{ (each part = £24)}$$

$$7 \times 24 = £168$$

£ 168

(Total for Question 7 is 4 marks)

8 (a) Write 0.00562 in standard form.

$$\frac{5.62 \times 10^{-3}}{(1)}$$

(b) Write 1.452×10^3 as an ordinary number.

$$\frac{1452}{(1)}$$

(Total for Question 8 is 2 marks)



9 The circumference of circle **B** is 90% of the circumference of circle **A**.

(a) Find the ratio of the area of circle **A** to the area of circle **B**.

~~Radius of B = 90% radius of A~~

	A : B	
LENGTHS	10 : 9	
AREA	100 : 81	(scale factor squared)

$$\frac{100 : 81}{(2)}$$

Square **E** has sides of length e cm.

Square **F** has sides of length f cm.

The area of square **E** is 44% greater than the area of square **F**.

(b) Work out the ratio $e:f$

AREA	E : F
	144 : 100
LENGTH	12 : 10
	6 : 5

$$\frac{6 : 5}{(2)}$$

(Total for Question 9 is 4 marks)



10 Mary travels to work by train every day.

The probability that her train will be late on any day is 0.15

(a) Complete the probability tree diagram for Thursday and Friday.

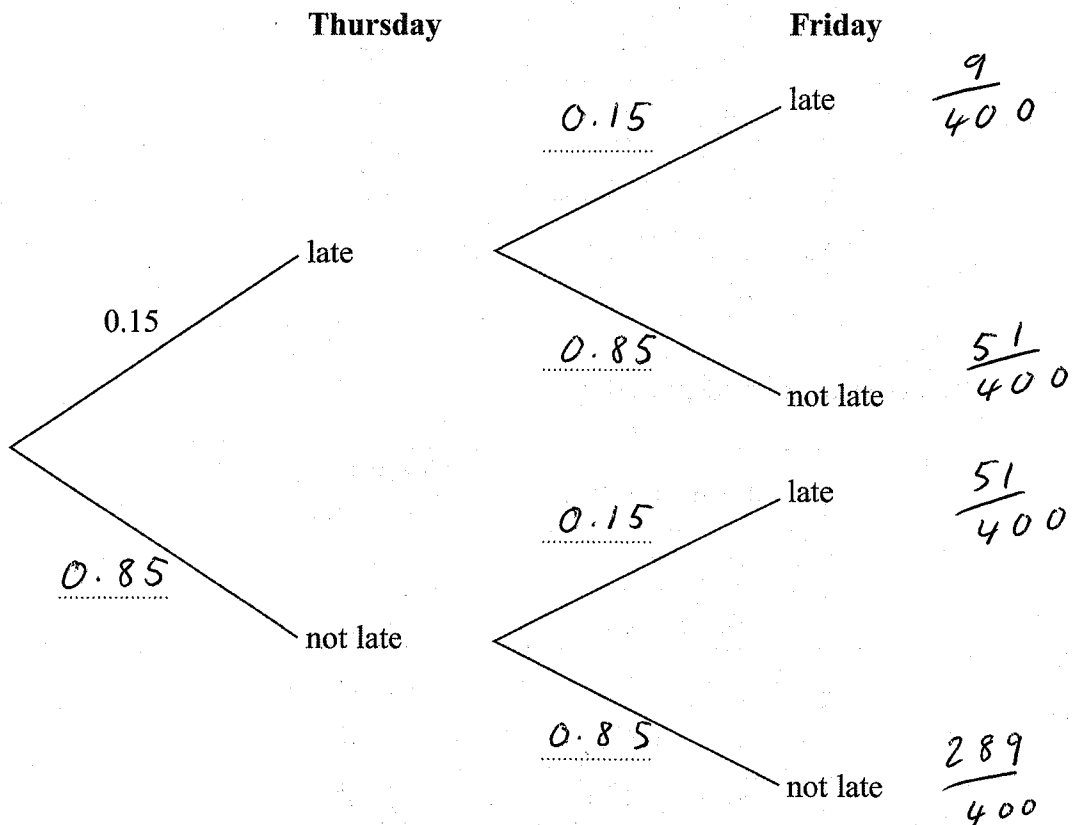

(2)

(b) Work out the probability that her train will be late on at least one of these two days.

$$P(\text{Late, Late}) = \frac{9}{400} \quad (0.15 \times 0.15)$$

$$P(\text{Late, Not Late}) = \frac{51}{400} \quad (0.15 \times 0.85)$$

$$P(\text{Not Late, Late}) = \frac{51}{400}$$

$$\frac{9}{400} + \frac{51}{400} + \frac{51}{400} = \frac{111}{400}$$

(3)

(Total for Question 10 is 5 marks)

- 11 The grouped frequency table gives information about the times, in minutes, that 80 office workers take to get to work.

Time (t minutes)	Frequency
$0 < t \leq 20$	5
$20 < t \leq 40$	30
$40 < t \leq 60$	20
$60 < t \leq 80$	15
$80 < t \leq 100$	8
$100 < t \leq 120$	2

- (a) Complete the cumulative frequency table.

Time (t minutes)	Cumulative frequency
$0 < t \leq 20$	5
$0 < t \leq 40$	35
$0 < t \leq 60$	55
$0 < t \leq 80$	70
$0 < t \leq 100$	78
$0 < t \leq 120$	80

(1)



(b) On the grid, draw the cumulative frequency graph for this information.

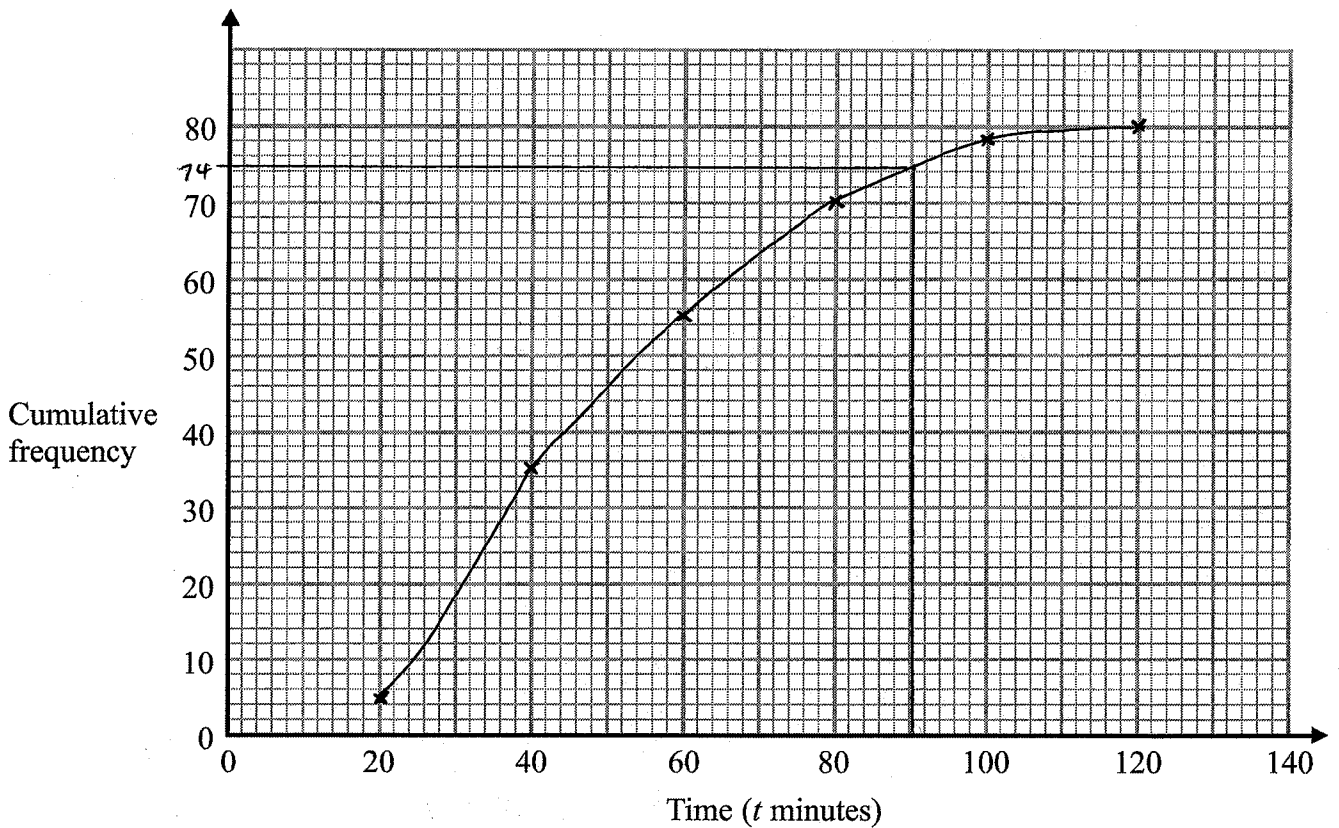

(2)

(c) Use your graph to find an estimate for the percentage of these office workers who take more than 90 minutes to get to work.

$$80 - 74 = 6$$

$$\frac{6}{80} \times 100 = 7.5\%$$

..... 7.5 %
(3)

(Total for Question 11 is 6 marks)

12 OAB is a sector of a circle with centre O and radius 7 cm.

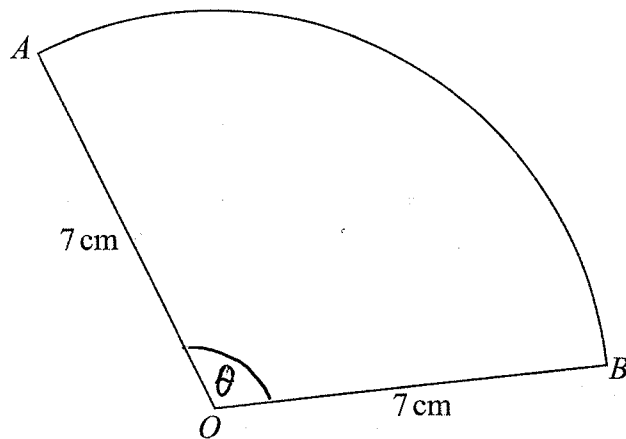

The area of the sector is 40 cm^2

Calculate the perimeter of the sector.

Give your answer correct to 3 significant figures.

$$\text{Sector Area} = \frac{\theta}{360} \times \pi r^2$$

$$40 = \frac{\theta}{360} \times \pi (7)^2$$

$$14400 = \theta \times 49\pi$$

$$\theta = \frac{14400}{49\pi} = 93.544^\circ$$

$$\text{Arc Length} = \frac{\theta}{360} \times 2\pi r$$

$$= \frac{93.544}{360} \times 2\pi (7)$$

$$= \frac{80}{7} = 11.4 \text{ cm (3sf)}$$

$$\text{Perimeter} = 7 + 7 + 11.4$$

$$= 25.4 \text{ cm}$$

..... 25.4 cm

(Total for Question 12 is 4 marks)



13 Show that $6 + \left[(x+5) \div \frac{x^2 + 3x - 10}{x-1} \right]$ simplifies to $\frac{ax-b}{cx-d}$ where a, b, c and d are integers.

$$x^2 + 3x - 10 = (x+5)(x-2)$$

$$6 + \left[x+5 \div \frac{(x+5)(x-2)}{x-1} \right]$$

$$6 + \left[x+5 \times \frac{x-1}{(x+5)(x-2)} \right]$$

$$6 + \frac{\cancel{(x+5)}(x-1)}{\cancel{(x+5)}(x-2)}$$

$$6 + \frac{x-1}{x-2}$$

$$\frac{6(x-2)}{(x-2)} + \frac{x-1}{(x-2)}$$

$$\frac{6x-12+x-1}{x-2}$$

$$\frac{7x-13}{x-2}$$

(Total for Question 13 is 4 marks)

14 A car moves from rest.

The graph gives information about the speed, v metres per second, of the car t seconds after it starts to move.

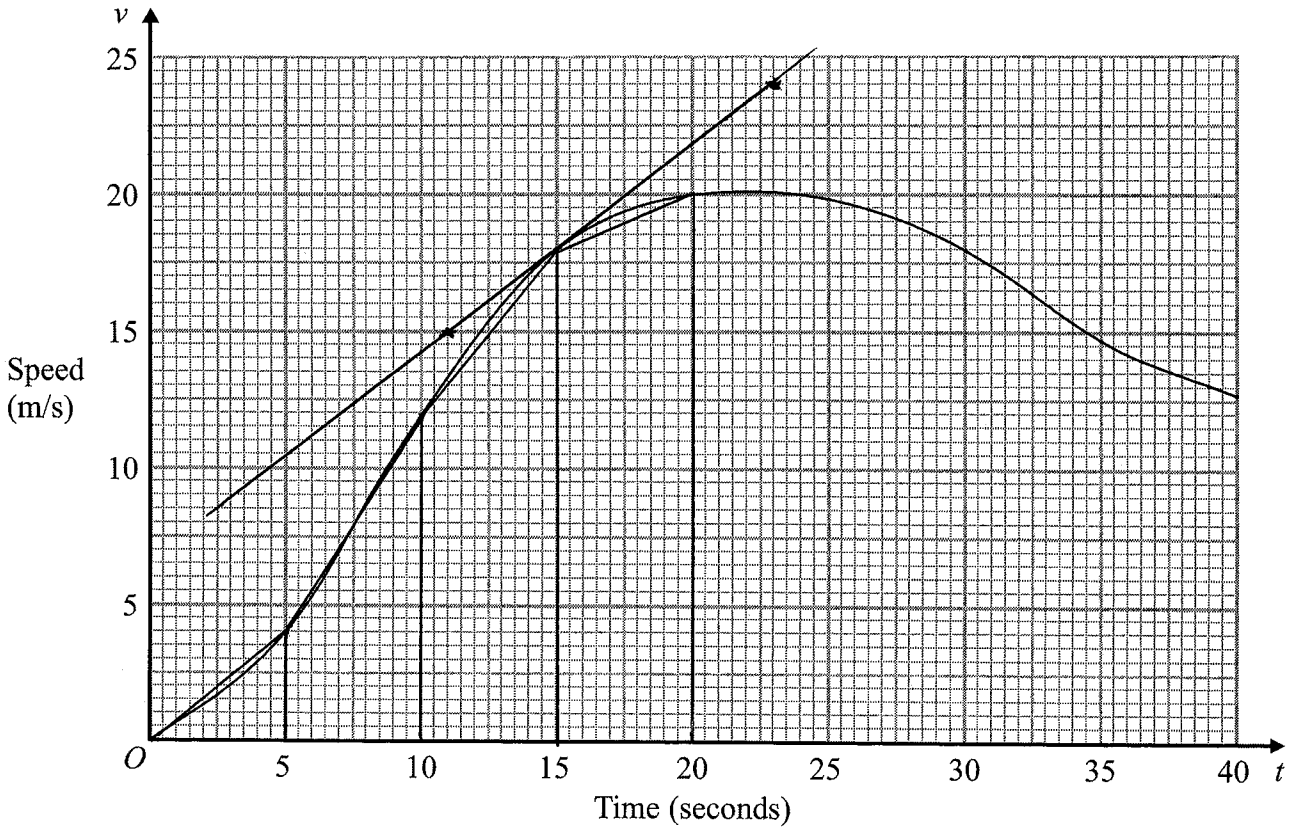

(a) (i) Calculate an estimate of the gradient of the graph at $t = 15$

$$(11, 15) \quad (23, 24) \quad m = \frac{y_2 - y_1}{x_2 - x_1}$$

$$\frac{24 - 15}{23 - 11} = \frac{9}{12} = 0.75$$

(ii) Describe what your answer to part (i) represents.

The Acceleration of the car after 15 seconds
 (1)

0.75
 [0.6⁽³⁾ → 1]

(at)



- (b) Work out an estimate for the distance the car travels in the first 20 seconds of its journey.
Use 4 strips of equal width.

$$\frac{1}{2} \times 5 \times 4 = 10$$

$$\frac{1}{2} (4 + 12) \times 5 = 40$$

$$\frac{1}{2} (12 + 18) \times 5 = 75$$

$$\frac{1}{2} (18 + 20) \times 5 = 95$$

$$10 + 40 + 75 + 95$$

$$\underline{\quad 220 \quad} \text{ m}$$

(3)

(Total for Question 14 is 7 marks)

- 15 Make m the subject of the formula $f = \frac{3m + 4}{m - 1}$

$$f(m - 1) = 3m + 4$$

$$fm - f = 3m + 4$$

$$fm = 3m + 4 + f$$

$$fm - 3m = 4 + f$$

$$m(f - 3) = 4 + f$$

$$m = \frac{4 + f}{f - 3}$$

$$\underline{\quad m = \frac{f + 4}{f - 3} \quad}$$

(Total for Question 15 is 3 marks)

- 16 The straight line L has the equation $3y = 4x + 7$.
The point A has coordinates (3, -5)

Find an equation of the straight line that is perpendicular to L and passes through A.

$$L \quad 3y = 4x + 7$$
$$y = \frac{4}{3}x + \frac{7}{3}$$

$$m = \frac{4}{3} \quad \therefore \text{perpendicular } m = -\frac{3}{4}$$

$$y = -\frac{3}{4}x + c \quad (3, -5)$$

$$-5 = -\frac{3}{4}(3) + c$$

$$-5 = -\frac{9}{4} + c$$

$$-20 = -9 + 4c$$

$$-11 = 4c$$

$$c = -\frac{11}{4}$$

$$y = -\frac{3}{4}x - \frac{11}{4}$$

(Total for Question 16 is 3 marks)



- 17 There are some small cubes and some large cubes in a bag.
The cubes are red or the cubes are yellow.

The ratio of the number of small cubes to the number of large cubes is 4:7 11 PARTS

The ratio of the number of red cubes to the number of yellow cubes is 3:5 8 PARTS

- (a) Explain why the least possible number of cubes in the bag is 88

88 is the lowest common multiple of 11
and 8

(1)

All the small cubes are yellow.

- (b) Work out the least possible number of large yellow cubes in the bag.

88 cubes

Small : large

$$\begin{array}{r} 4 : 7 \\ \times 8 \quad \times 8 \end{array}$$

$$32 : 56$$

red : yellow

$$\begin{array}{r} 3 : 5 \\ \times 11 \quad \times 11 \end{array}$$

$$33 : 55$$

$$55 - 32 = \underline{\underline{23}}$$

23

(3)

(Total for Question 17 is 4 marks)

- 18 The points A, B, C and D lie on a circle.
 CDE is a straight line.

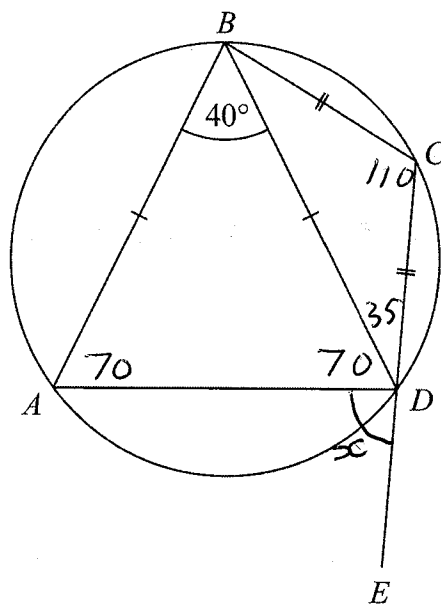

$BA = BD$
 $CB = CD$
 Angle $ABD = 40^\circ$

Work out the size of angle ADE .
 You must give a reason for each stage of your working.

$$\angle BAD \text{ and } \angle ADB = \frac{180 - 40}{2} = 70^\circ$$

Angles at the base of an isosceles triangle are equal

$$\angle BCD = 180 - 70 = 110$$

Opposite angles in a cyclic quadrilateral are equal

$$\angle CBD = \frac{180 - 110}{2} = 35^\circ$$

Angles at the base of an isosceles

$$x = 180 - 70 - 35 = 75^\circ$$

Angles on a straight line sum to 180°

(Total for Question 18 is 5 marks)



19 The diagram shows a triangular prism.

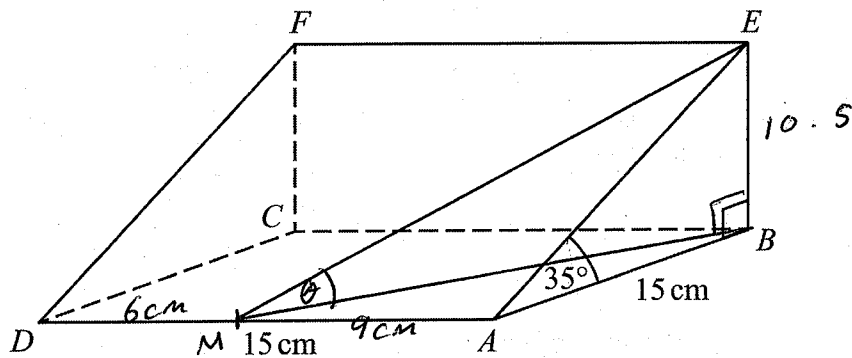

The base, $ABCD$, of the prism is a square of side length 15 cm.
 Angle ABE and angle CBE are right angles.
 Angle $EAB = 35^\circ$

M is the point on DA such that

$$DM : MA = 2 : 3$$

$$DM : MA = 2 : 3$$

Calculate the size of the angle between EM and the base of the prism.
 Give your answer correct to 1 decimal place.

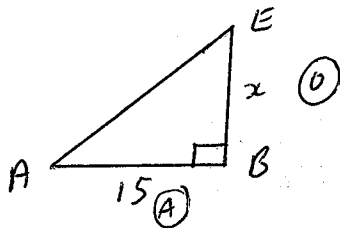

$$\tan 35 = \frac{x}{15}$$

$$15 \tan 35 = x$$

$$x = 10.50311\dots$$

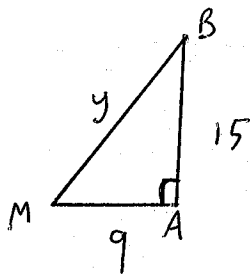

$$y^2 = 15^2 + 9^2$$

$$y^2 = 306$$

$$y = \sqrt{306}$$

$$y = 17.49285\dots$$

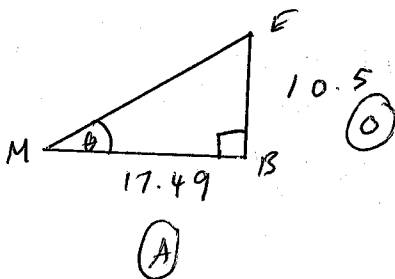

$$\tan \theta = \frac{10.5}{17.49}$$

$$\theta = \tan^{-1} \left(\frac{10.5}{17.49} \right)$$

$$= 30.981\dots$$

$$= \underline{\underline{31.0^\circ}}$$

31.0

(Total for Question 19 is 4 marks)

20 CDEF is a quadrilateral.

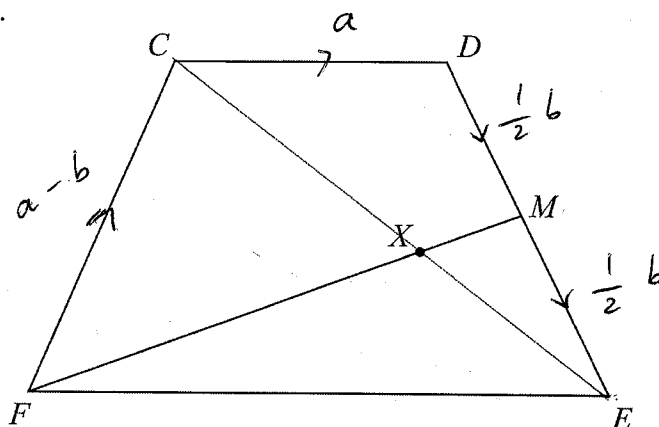

$\vec{CD} = \mathbf{a}$, $\vec{DE} = \mathbf{b}$ and $\vec{FC} = \mathbf{a} - \mathbf{b}$.

- (a) Express \vec{FE} in terms of \mathbf{a} and/or \mathbf{b} .
Give your answer in its simplest form.

$$\vec{FE} = \mathbf{a} - \mathbf{b} + \mathbf{a} + \mathbf{b}$$

$$2\mathbf{a}$$

(2)

M is the midpoint of DE.

X is the point on FM such that $FX:XM = n:1$

CXE is a straight line.

- (b) Work out the value of n.

Let $\vec{FX} = x \vec{FM}$

$\vec{CX} = y (\vec{CE})$

$\vec{CE} = \mathbf{a} + \mathbf{b}$

$\vec{FM} = \mathbf{a} - \mathbf{b} + \mathbf{a} + \frac{1}{2}\mathbf{b}$

$= 2\mathbf{a} - \frac{1}{2}\mathbf{b}$

$\vec{CX} = y(\mathbf{a} + \mathbf{b})$

$\vec{FX} = x(2\mathbf{a} - \frac{1}{2}\mathbf{b})$

$= y\mathbf{a} + y\mathbf{b}$

$= 2x\mathbf{a} - \frac{1}{2}x\mathbf{b}$

$\vec{CX} = -\mathbf{a} + \mathbf{b} + 2x\mathbf{a} - \frac{1}{2}x\mathbf{b}$

$y\mathbf{a} + y\mathbf{b} = -\mathbf{a} + \mathbf{b} + 2x\mathbf{a} - \frac{1}{2}x\mathbf{b}$

$\therefore y = -1 + 2x$ b// $y = 1 - \frac{1}{2}x$

$-1 + 2x = 1 - \frac{1}{2}x$

$n = \frac{4}{1}$

(4)

$\frac{5}{2}x = 2$ $x = \frac{4}{5}$

$\vec{FX} = \frac{4}{5}$ of \vec{FM}

\therefore Ratio 4 : 1

(Total for Question 20 is 6 marks)

TOTAL FOR PAPER IS 80 MARKS



DO NOT WRITE IN THIS AREA

DO NOT WRITE IN THIS AREA

DO NOT WRITE IN THIS AREA