

Pearson Education accepts no responsibility whatsoever for the accuracy or method of working in the answers given.

Write your name here		
Surname	Other names	
Pearson Edexcel	Centre Number	Candidate Number
Level 1 / Level 2	<input type="text"/> <input type="text"/> <input type="text"/> <input type="text"/> <input type="text"/>	<input type="text"/> <input type="text"/> <input type="text"/> <input type="text"/> <input type="text"/>
GCSE (9–1)		
Mathematics		
Paper 3 (Calculator)		
		Foundation Tier
Tuesday 13 June 2017 – Morning		Paper Reference
Time: 1 hour 30 minutes		1MA1/3F
You must have: Ruler graduated in centimetres and millimetres, protractor, pair of compasses, pen, HB pencil, eraser, calculator. Tracing paper may be used.		Total Marks

Instructions

- Use **black** ink or ball-point pen.
- **Fill in the boxes** at the top of this page with your name, centre number and candidate number.
- Answer **all** questions.
- Answer the questions in the spaces provided
– *there may be more space than you need.*
- You must **show all your working**.
- Diagrams are **NOT** accurately drawn, unless otherwise indicated.
- **Calculators may be used.**
- If your calculator does not have a π button, take the value of π to be 3.142 unless the question instructs otherwise.



Information

- The total mark for this paper is 80
- The marks for **each** question are shown in brackets
– *use this as a guide as to how much time to spend on each question.*

Advice

- Read each question carefully before you start to answer it.
- Keep an eye on the time.
- Try to answer every question.
- Check your answers if you have time at the end.

Turn over ►

P50548A

©2017 Pearson Education Ltd.
6/6/6/6/6/6/7/7/4/



Pearson

Answer ALL questions.

Write your answers in the spaces provided.

You must write down all the stages in your working.

1 The table shows the lengths of five rivers.

River	Length (km)
Trent	297
Don	112
Severn	354
Thames	346
Mersey	113

(a) Write down the rivers in order of length.

Start with the shortest river.

Don, Mersey, Trent, Thames, Severn

(1)

Ami says,

“The River Thames is more than three times as long as the River Don.”

(b) Show that Ami is correct.

$$112 \times 3 = 336$$

346 is more than 336

(1)

(Total for Question 1 is 2 marks)



DO NOT WRITE IN THIS AREA

DO NOT WRITE IN THIS AREA

DO NOT WRITE IN THIS AREA

2 Cups are sold in packs and in boxes.

There are 12 cups in each pack.
There are 18 cups in each box.

Alison buys p packs of cups and b boxes of cups.

Write down an expression, in terms of p and b , for the total number of cups Alison buys.

$$12p + 18b$$

(Total for Question 2 is 2 marks)

3 Here are four digits.

5 6 1 9

(i) Write down the smallest possible two digit number that can be made with two of the digits.

$$15$$

(1)

(ii) Write down the three digit number closest to 200 that can be made with three of the digits.

$$196$$

(1)

(Total for Question 3 is 2 marks)



4 $\frac{4}{5}$ of a number is 32

Find the number.

$$\begin{aligned} \frac{4}{5}x &= 32 \\ \div 4 & \qquad \qquad \div 4 \\ \frac{1}{5}x &= 8 \\ \times 5 & \qquad \qquad \times 5 \\ \underline{x} &= \underline{40} \end{aligned}$$

40

(Total for Question 4 is 2 marks)

5 A path is made of white tiles and grey tiles.

$\frac{1}{4}$ of the tiles are white.

(a) Write down the ratio of white tiles to grey tiles.

$$\begin{aligned} \frac{1}{4} &: \frac{3}{4} \\ 1 &: 3 \end{aligned}$$

1 : 3
(1)

There is a total of 56 tiles.

(b) Work out the number of grey tiles.

4 parts

$$\frac{56}{4} = 14$$

$$\boxed{14} : \boxed{14} \boxed{14} \boxed{14}$$

$$14 : 42$$

42
(2)

(Total for Question 5 is 3 marks)



DO NOT WRITE IN THIS AREA

DO NOT WRITE IN THIS AREA

DO NOT WRITE IN THIS AREA

6 Here is a list of numbers.

12 15 14 17 22 19 13

Bridgit says,

“To work out the median you find the middle number, so the median of these numbers is 17”

Bridgit’s answer is **not** correct.

(a) What is wrong with Bridgit’s method?

The numbers are not in order

(1)

(b) Work out the range of the numbers in the list.

$$22 - 12$$

10

(2)

(c) Work out the mean of the numbers in the list.

$$\frac{12 + 15 + 14 + 17 + 22 + 19 + 13}{7}$$

16

(2)

(Total for Question 6 is 5 marks)



P 5 0 5 4 8 A 0 5 2 0

- 7 Priti is going to have a meal.
She can choose one starter and one main course from the menu.

Menu	
Starter	Main Course
Salad	Pasta
Fish	Rice
Melon	Burger

Write down all the possible combinations Priti can choose.

Salad Pasta Fish Pasta Melon Pasta
 Salad Rice Fish Rice Melon Rice
 Salad Burger Fish Burger Melon Burger

(Total for Question 7 is 2 marks)

- 8 Joanne wants to buy a dishwasher.

The dishwasher costs £372

Joanne will pay a deposit of £36

She will then pay the rest of the cost in 4 equal monthly payments.

How much is each monthly payment?

$$372 - 36 = 336$$

$$\frac{336}{4} = £84$$

£ 84

(Total for Question 8 is 2 marks)



9 Davos is a cleaner.

The table shows information about the time it will take him to clean each of four rooms in a house.

Room	Time
Kitchen	2 hours
Sitting room	1 hour 40 minutes
Bedroom	$1\frac{1}{2}$ hours
Bathroom	45 minutes

120 mins
100 mins
90 mins
45 mins

355 mins

Davos wants to clean all four rooms in one day.
He will have breaks for a total time of 75 minutes.

Davos is going to start cleaning at 9 am.

Will he finish cleaning by 4 pm?
You must show all your working.

$$355 + 75 = 430 \text{ minutes}$$

$$\frac{430}{60} = 7.1\bar{6} \text{ hours}$$

$$= 7 \text{ hours } 10 \text{ minutes}$$

STARTED AT 9 AM

7 HOURS TO 4 PM

No he will not finish by 4 pm.

(Total for Question 9 is 3 marks)



10 ABC is a straight line.

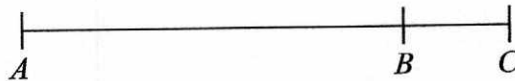

The length AB is five times the length BC .

$AC = 90$ cm.

Work out the length AB .

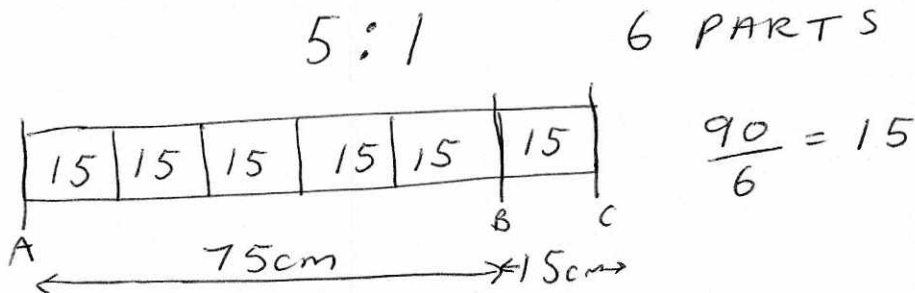

..... 75 cm

(Total for Question 10 is 3 marks)

11 $T = 4v + 3$

(a) Work out the value of T when $v = 2$

$$T = 4(2) + 3$$

$$= 11$$

$T =$ 11
(2)

(b) Make v the subject of the formula $T = 4v + 3$

$$\frac{T-3}{4} = \frac{4v}{4}$$

$$v = \frac{T-3}{4}$$

$$v = \frac{T-3}{4}$$

.....
(2)

(Total for Question 11 is 4 marks)



12 The diagram shows a cube of side length 2 cm.

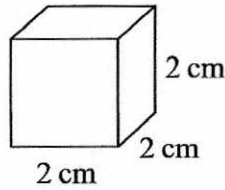

Vera says,

“The volume of any solid made with 6 of these cubes is 48 cm^3 ”

(a) Is Vera correct?

You must show your working.

$$\text{Volume} = 2^3 = 8 \text{ cm}^3$$

$$\frac{48}{8} = 6$$

Yes Vera is correct.

(b) (i) Draw a cuboid that can be made with 6 of these cubes.
Write the dimensions of the cuboid on your diagram.

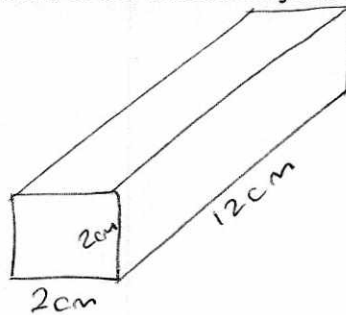

ii//
OR

 ii//
 $2 \times 4 = 8 \text{ cm}^2$
 $2 \times 6 = 12 \text{ cm}^2$
 $4 \times 6 = 24 \text{ cm}^2$
 (1)
 $2(8) + 2(12) + 2(24)$
 $= 88 \text{ cm}^2$

(ii) Work out the surface area of your cuboid.

$$2 \text{ Front} \times \text{Back} \quad 4 \text{ cm}^2$$

$$\text{Sides} \quad 24 \text{ cm}^2$$

$$2(4) + 4(24) = 104 \text{ cm}^2$$

$$\underline{\quad 104 \quad} \text{ cm}^2$$

(2)
OR 88 cm^2

(Total for Question 12 is 5 marks)



DO NOT WRITE IN THIS AREA

DO NOT WRITE IN THIS AREA

DO NOT WRITE IN THIS AREA

13 The size of the largest angle in a triangle is 4 times the size of the smallest angle.
The other angle is 27° less than the largest angle.

Work out, in degrees, the size of each angle in the triangle.
You must show your working.

$$\begin{aligned}x \\ 4x \\ 4x - 27\end{aligned}$$

$$x + 4x + 4x - 27 = 180$$

$$9x - 27 = 180$$

$$9x = 207$$

$$x = 23$$

$$23^\circ, 92^\circ, 65^\circ$$

(Total for Question 13 is 5 marks)



DO NOT WRITE IN THIS AREA

14 Andy went on holiday to Canada.
His flights cost a total of £1500

Andy stayed for 14 nights.
His hotel room cost \$196 per night.

$$14 \times 196 = \$2744$$

Andy used wifi for 12 days.
Wifi cost \$5 per day.

$$12 \times 5 = \$60$$

The exchange rate was \$1.90 to £1

(a) Work out the total cost of the flights, the hotel room and wifi.
Give your answer in pounds.

$$\begin{aligned} \text{Room and wifi} &= 2744 + 60 \\ &= \$2804 \end{aligned}$$

$$\frac{2804}{1.9} = \pounds 1475.79$$

$$1475.79 + 1500 = \pounds 2975.79$$

$$\pounds \underline{2975.79}$$

(5)

(b) If there were fewer dollars to £1, what effect would this have on the total cost, in pounds, of Andy's holiday?

It would cost more.

(1)

(Total for Question 14 is 6 marks)



P 5 0 5 4 8 A 0 1 1 2 0

- 15 $\mathcal{E} = \{\text{odd numbers less than } 30\}$
 $A = \{3, 9, 15, 21, 27\}$
 $B = \{5, 15, 25\}$

(a) Complete the Venn diagram to represent this information.

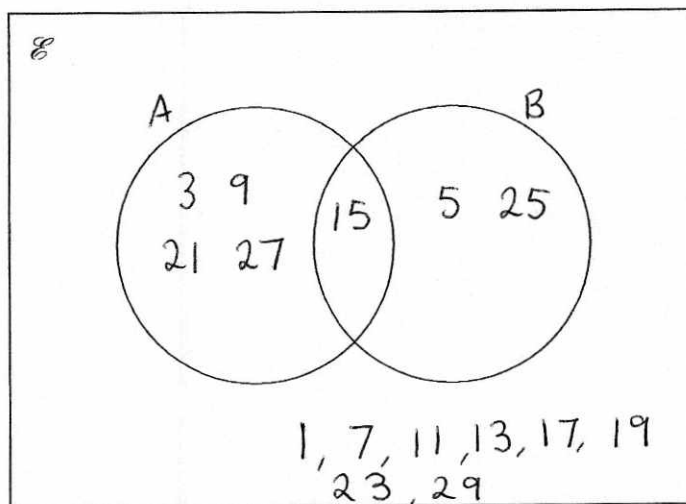

(4)

A number is chosen at random from the universal set, \mathcal{E} .

(b) What is the probability that the number is in the set $A \cup B$?

$$\frac{7}{15}$$

(2)

(Total for Question 15 is 6 marks)



16 Solve the simultaneous equations

$$\begin{aligned}3x + y &= -4 \\ 3x - 4y &= 6\end{aligned}$$

$$5y = -10$$

$$y = -2$$

$$3x - 2 = -4$$

$$3x = -2$$

$$x = -\frac{2}{3}$$

$$x = \dots\dots\dots -\frac{2}{3}$$

$$y = \dots\dots\dots -2$$

(Total for Question 16 is 3 marks)



17 The table shows some information about the dress sizes of 25 women.

Dress size	Number of women
8	2
10	9
12	8
14	6

(a) Find the median dress size.

12

(1)

3 of the 25 women have a shoe size of 7

Zoe says that if you choose at random one of the 25 women, the probability that she has either a shoe size of 7 or a dress size of 14 is $\frac{9}{25}$ because

$$\frac{3}{25} + \frac{6}{25} = \frac{9}{25}$$

(b) Is Zoe correct?

You must give a reason for your answer.

No some of them might have shoe size
9 AND dress size 14.

(1)

(Total for Question 17 is 2 marks)



DO NOT WRITE IN THIS AREA

DO NOT WRITE IN THIS AREA

DO NOT WRITE IN THIS AREA

18 Daniel bakes 420 cakes.

He bakes only vanilla cakes, banana cakes, lemon cakes and chocolate cakes.

$\frac{2}{7}$ of the cakes are vanilla cakes.

35% of the cakes are banana cakes.

The ratio of the number of lemon cakes to the number of chocolate cakes is 4:5

Work out the number of lemon cakes Daniel bakes.

$$\frac{2}{7} \times 420 = 120 \text{ Vanilla}$$

$$0.35 \times 420 = 147 \text{ Banana}$$

$$420 - 147 - 120 = 153$$

$$\begin{array}{l} L : C \\ \boxed{17} \boxed{17} \boxed{17} \boxed{17} : \boxed{17} \boxed{17} \boxed{17} \boxed{17} \boxed{17} \\ 68 : 85 \end{array} \quad \frac{153}{9} = 17$$

68

(Total for Question 18 is 5 marks)



P 5 0 5 4 8 A 0 1 5 2 0

19 In the diagram, AB , BC and CD are three sides of a regular polygon P .

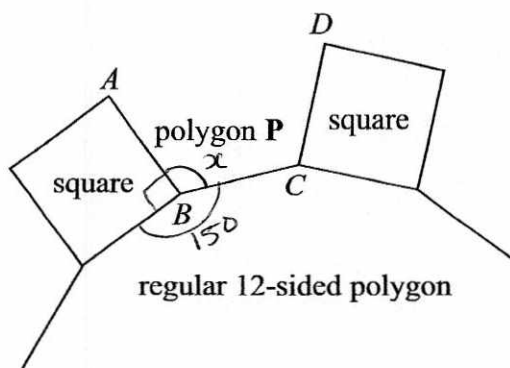

Show that polygon P is a hexagon.
You must show your working.

$$\frac{360}{12} = 30 \quad \text{Exterior Angle of 12 sided-p.}$$

$$180 - 30 = 150 \quad \text{Interior Angle of 12 S-P.}$$

$$\text{Polygon P: } x = 360 - 90 - 150 = 120$$

Interior angle of P is 120

$$\text{Exterior Angle of } P = 180 - 120 = 60$$

$$\frac{360}{60} = 6 \quad \begin{array}{l} P \text{ has 6 sides} \\ P \text{ is a hexagon.} \end{array}$$

(Total for Question 19 is 4 marks)



DO NOT WRITE IN THIS AREA

20 The density of apple juice is 1.05 grams per cm^3 .

The density of fruit syrup is 1.4 grams per cm^3 .

The density of carbonated water is 0.99 grams per cm^3 .

25 cm^3 of apple juice are mixed with 15 cm^3 of fruit syrup and 280 cm^3 of carbonated water to make a drink with a volume of 320 cm^3 .

Work out the density of the drink.

Give your answer correct to 2 decimal places.



$$\text{Apple Mass} = 1.05 \times 25 = 26.25$$

$$\text{Fruit Syrup Mass} = 1.4 \times 15 = 21$$

$$\text{C. Water Mass} = 0.99 \times 280 = 277.2$$

$$\text{Total Mass} = 324.45 \quad \text{Total Volume} = 320$$

$$\begin{aligned} \text{Density} &= \frac{324.45}{320} \\ &= 1.01 \text{ g/cm}^3 \text{ (2dp)} \end{aligned}$$

$$\dots\dots\dots 1.01 \dots\dots\dots \text{g/cm}^3$$

(Total for Question 20 is 4 marks)



21

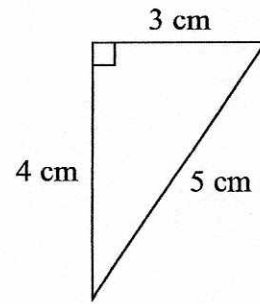
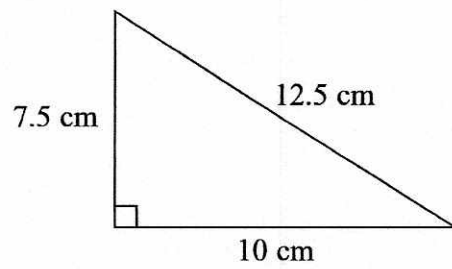

Show that these two triangles are mathematically similar.

$$\frac{7.5}{3} = 2.5$$

$$\frac{10}{4} = 2.5$$

$$\frac{12.5}{5} = 2.5$$

All sides have the same scale factor.

(Total for Question 21 is 2 marks)

DO NOT WRITE IN THIS AREA

DO NOT WRITE IN THIS AREA

DO NOT WRITE IN THIS AREA



22 (a) Complete the table of values for $y = \frac{6}{x}$

x	0.5	1	1.5	2	3	4	5	6
y	12	6	4	3	2	1.5	1.2	1

(2)

(b) On the grid below, draw the graph of $y = \frac{6}{x}$ for values of x from 0.5 to 6

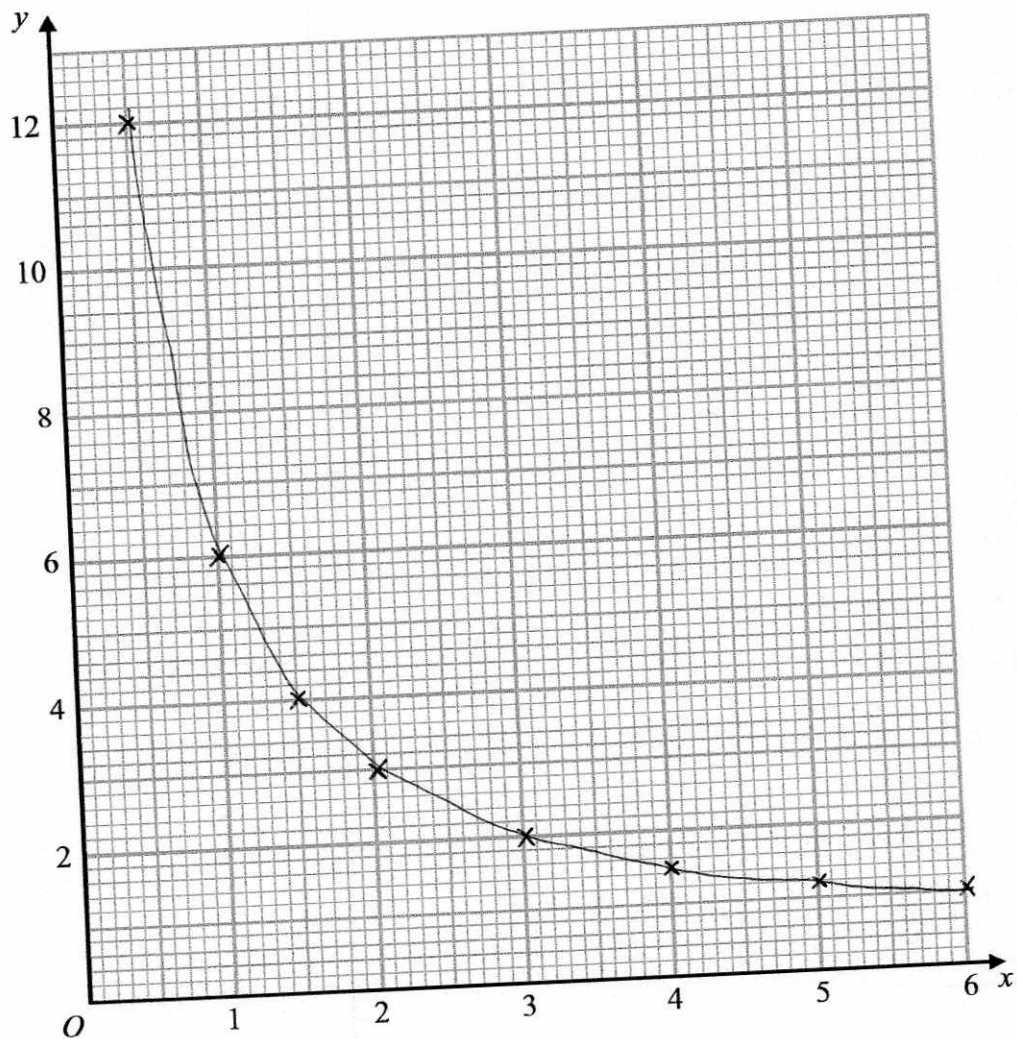

(2)

(Total for Question 22 is 4 marks)



DO NOT WRITE IN THIS AREA

DO NOT WRITE IN THIS AREA

DO NOT WRITE IN THIS AREA

23 Harley's house has a value of £160 000 correct to 2 significant figures.

(a) (i) Write down the least possible value of the house.

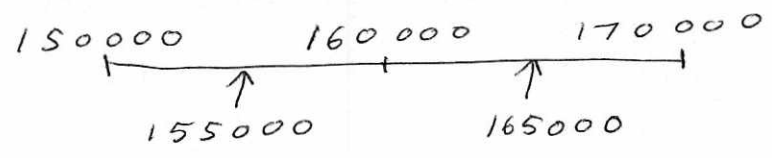

£ 155 000
(1)

(ii) Write down the greatest possible value of the house.

£ 165 000
(1)

The value of Rita's house increased by 5%.
Her house then had a value of £210 000

(b) Work out the value of Rita's house before the increase.

$$105\% = 210\,000$$

$$\div 105 \qquad \div 105$$

$$1\% = 2\,000$$

$$\times 100 \qquad \times 100$$

$$100\% = 200\,000$$

£ 200 000
(2)

(Total for Question 23 is 4 marks)

TOTAL FOR PAPER IS 80 MARKS

