

Write your name here

Surname

Other names

Centre Number

Candidate Number

**Edexcel GCSE**

# Mathematics A

## Paper 2 (Calculator)

**Higher Tier**

Friday 14 June 2013 – Morning

**Time: 1 hour 45 minutes**

Paper Reference

**1MA0/2H**

**You must have:** Ruler graduated in centimetres and millimetres, protractor, pair of compasses, pen, HB pencil, eraser, calculator. Tracing paper may be used.

Total Marks

### Instructions

- Use **black** ink or ball-point pen.
- **Fill in the boxes** at the top of this page with your name, centre number and candidate number.
- Answer **all** questions.
- Answer the questions in the spaces provided – *there may be more space than you need.*
- **Calculators may be used.**
- If your calculator does not have a  $\pi$  button, take the value of  $\pi$  to be 3.142 unless the question instructs otherwise.



### Information

- The total mark for this paper is 100
- The marks for **each** question are shown in brackets – *use this as a guide as to how much time to spend on each question.*
- Questions labelled with an **asterisk** (\*) are ones where the quality of your written communication will be assessed.

### Advice

- Read each question carefully before you start to answer it.
- Keep an eye on the time.
- Try to answer every question.
- Check your answers if you have time at the end.

Turn over ►

P43600A

©2013 Pearson Education Ltd.

6/5/5/



**PEARSON**

# GCSE Mathematics 1MA0

## Formulae: Higher Tier

**You must not write on this formulae page.  
Anything you write on this formulae page will gain NO credit.**

**Volume of prism** = area of cross section  $\times$  length

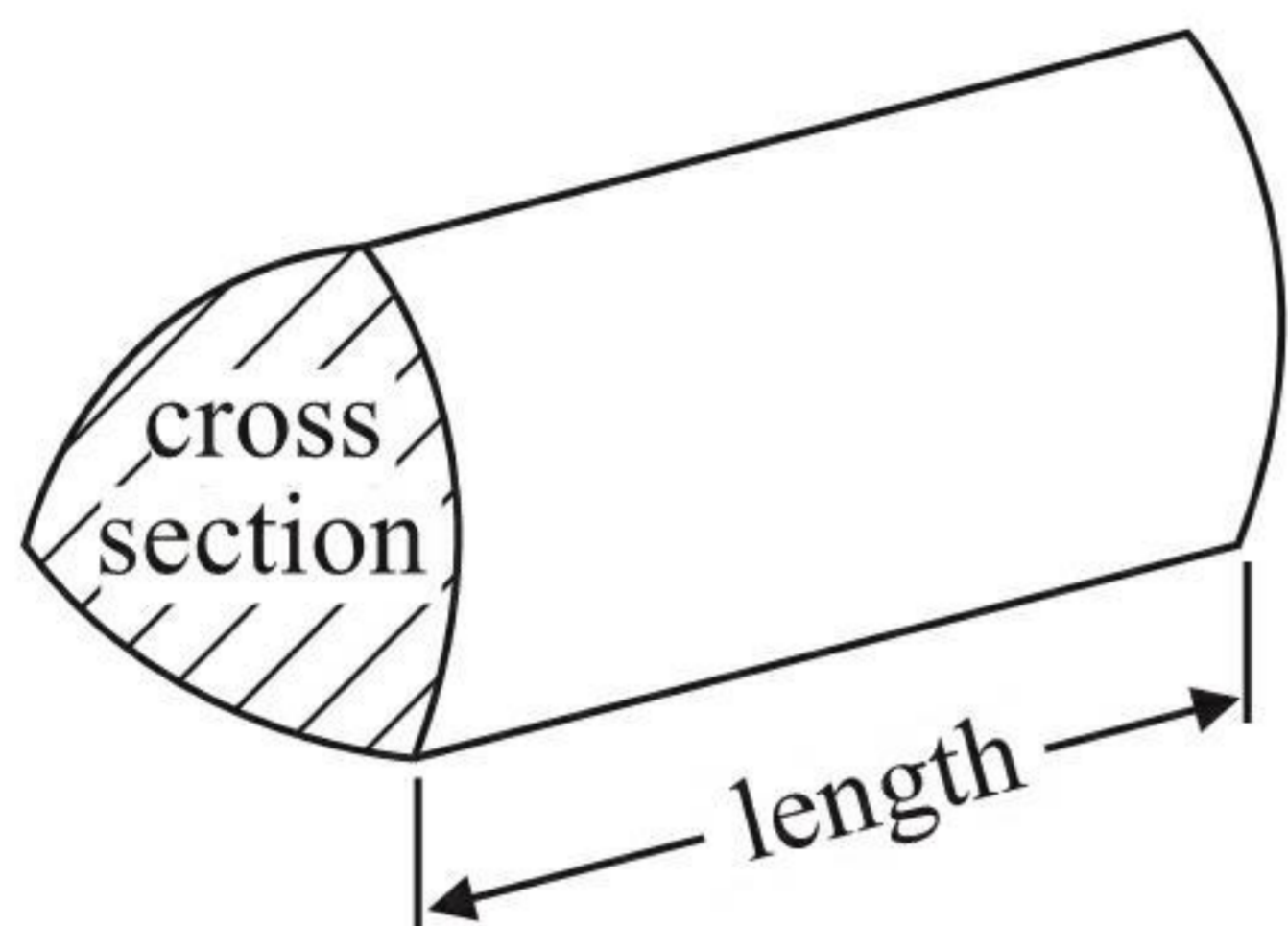

**Area of trapezium** =  $\frac{1}{2} (a + b)h$

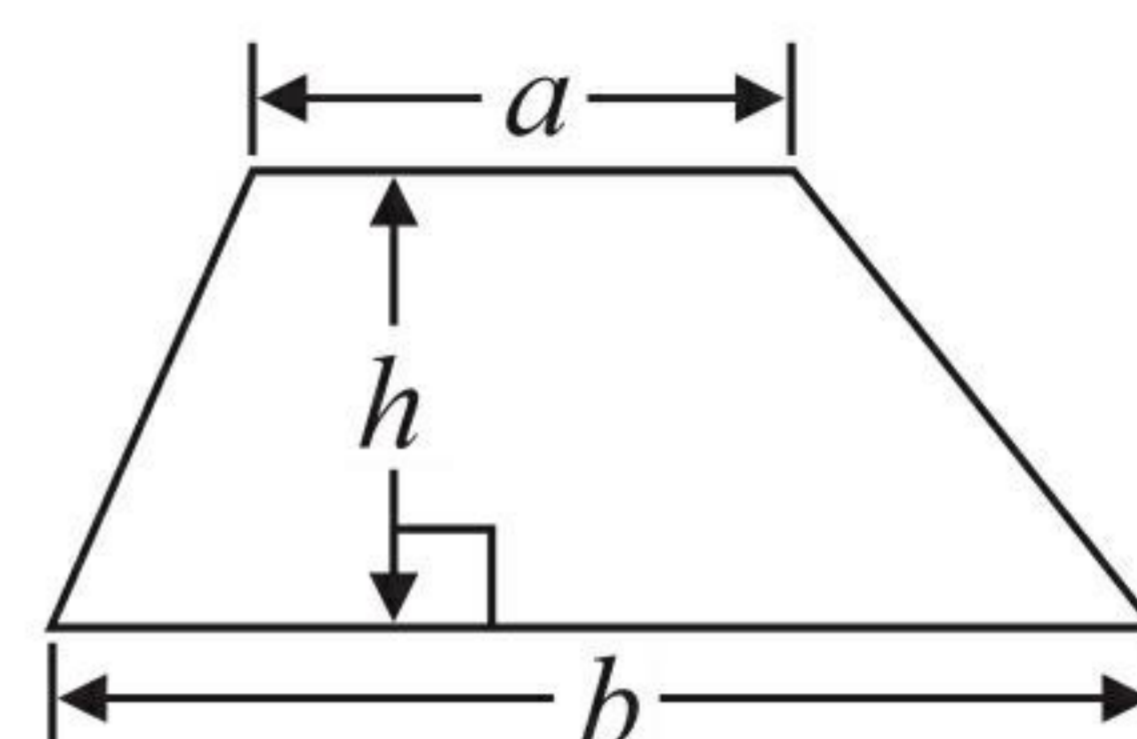

**Volume of sphere** =  $\frac{4}{3} \pi r^3$

**Surface area of sphere** =  $4\pi r^2$

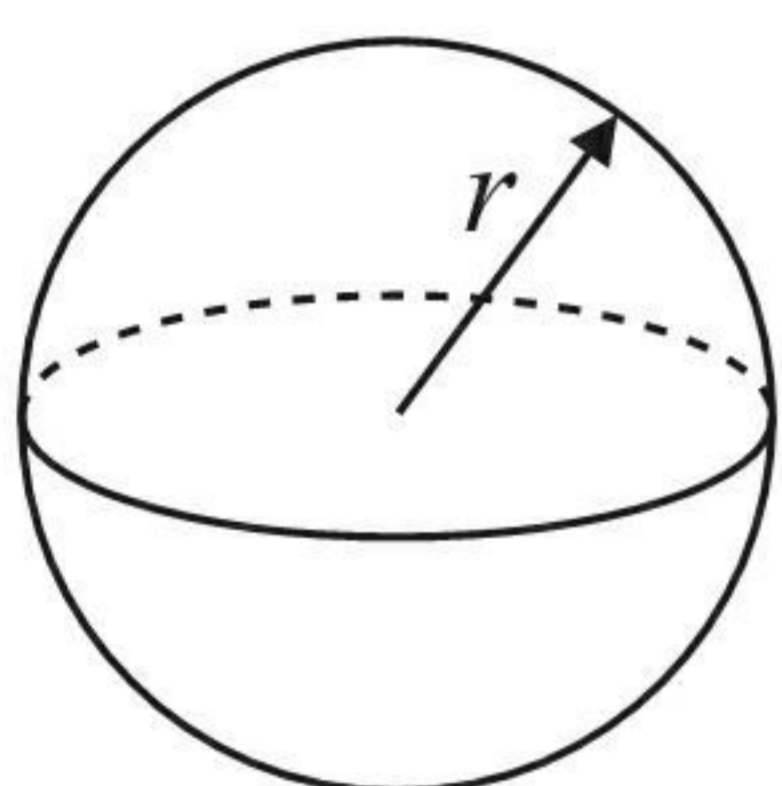

**Volume of cone** =  $\frac{1}{3} \pi r^2 h$

**Curved surface area of cone** =  $\pi r l$

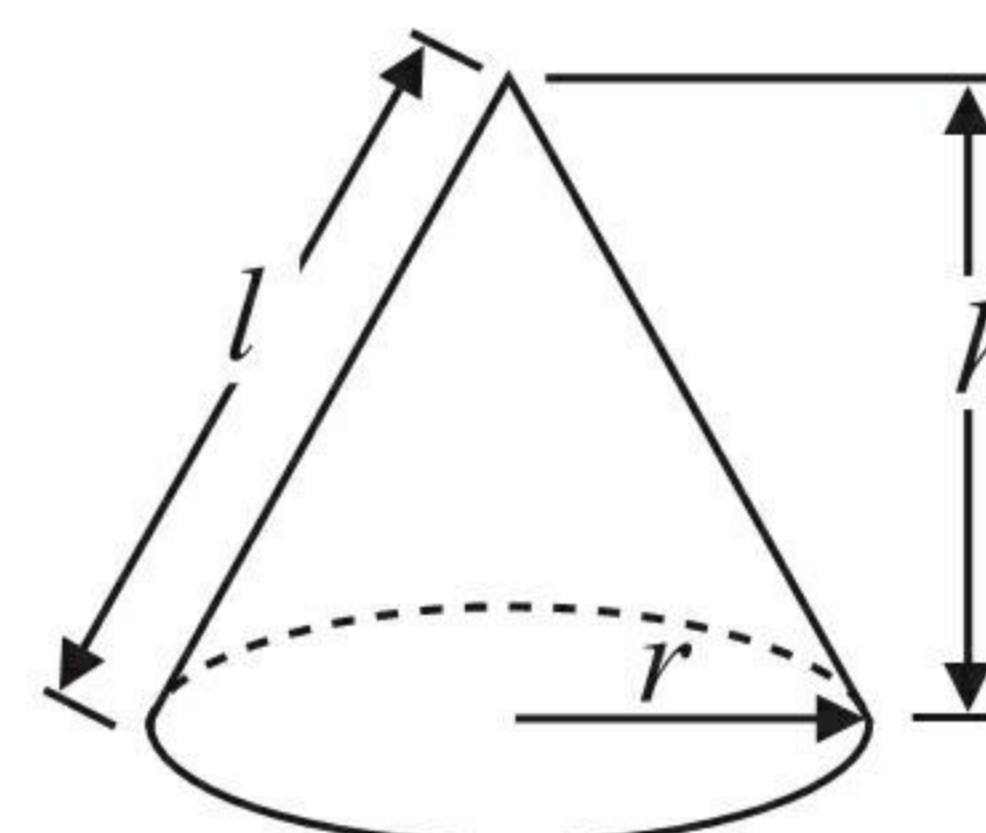

**In any triangle ABC**

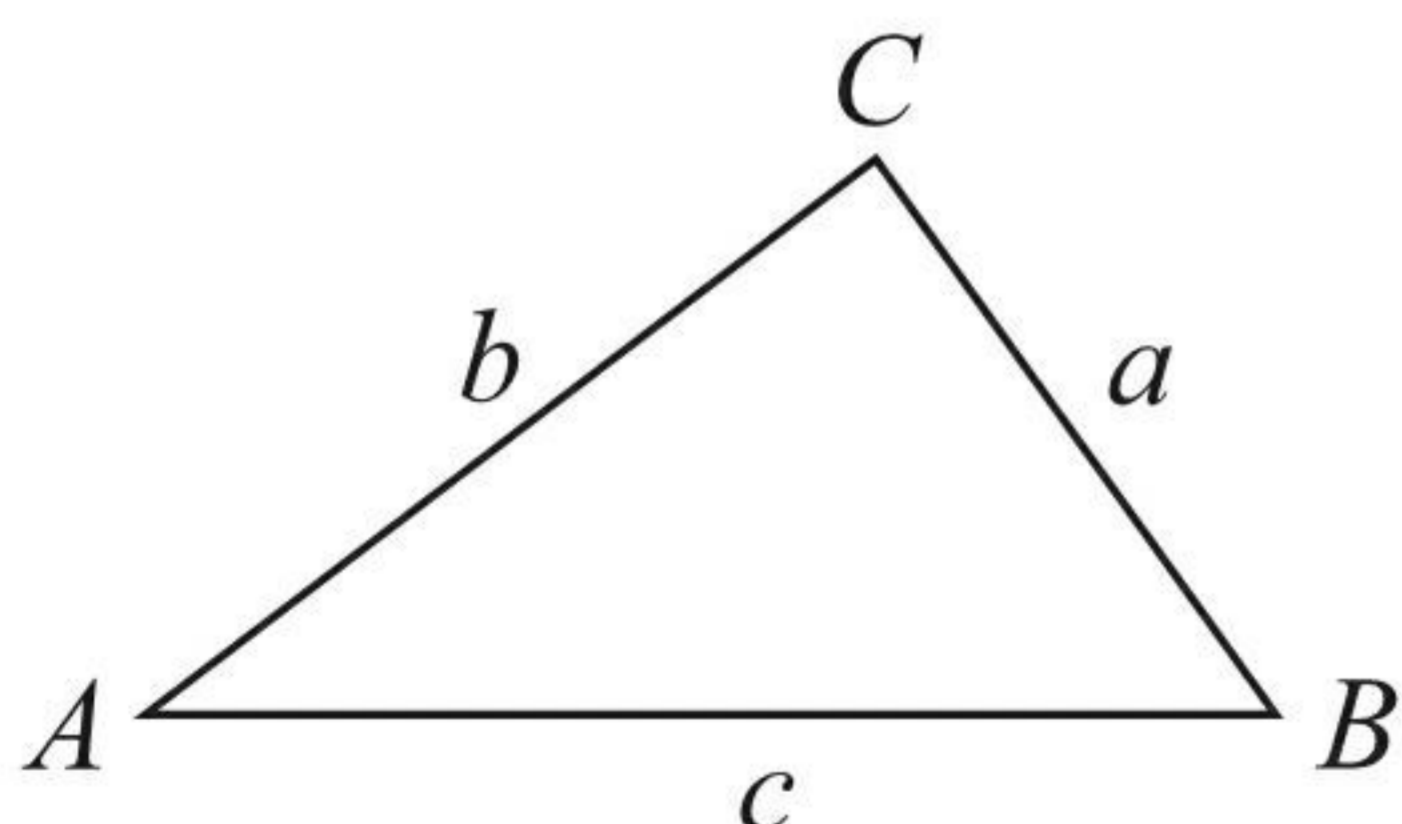

**The Quadratic Equation**

The solutions of  $ax^2 + bx + c = 0$   
where  $a \neq 0$ , are given by

$$x = \frac{-b \pm \sqrt{b^2 - 4ac}}{2a}$$

**Sine Rule**  $\frac{a}{\sin A} = \frac{b}{\sin B} = \frac{c}{\sin C}$

**Cosine Rule**  $a^2 = b^2 + c^2 - 2bc \cos A$

**Area of triangle** =  $\frac{1}{2} ab \sin C$



Answer ALL questions.

Write your answers in the spaces provided.

You must write down all stages in your working.

1 Here is a cuboid.

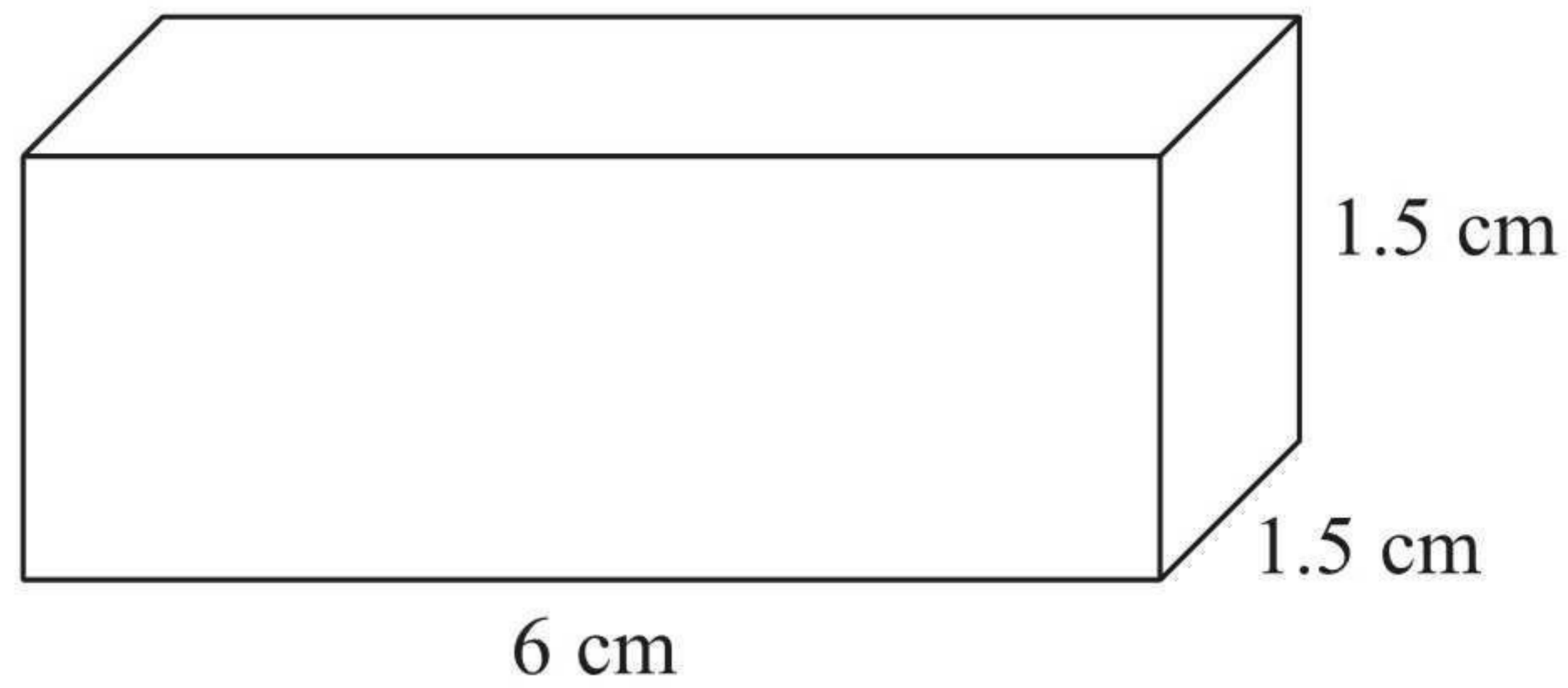

Diagram **NOT**  
accurately drawn

The cuboid is 6 cm by 1.5 cm by 1.5 cm.

Work out the total surface area of the cuboid.

$$1.5 \times 6 = 9$$

$$1.5 \times 1.5 = 2.25$$

$$(9 \times 4) + (2.25 \times 2)$$

40.5 cm<sup>2</sup>

(Total for Question 1 is 3 marks)



\*2 Here is a list of ingredients for making 18 mince pies.

Ingredients for 18 mince pies	<u>x 2.5</u>
225 g of butter	
350 g of flour	
100 g of sugar	
280 g of mincemeat	
1 egg	

Elaine wants to make 45 mince pies.

Elaine has

- 1 kg of butter
- 1 kg of flour
- 500 g of sugar
- 600 g of mincemeat
- 6 eggs

Does Elaine have enough of each ingredient to make 45 mince pies?

You must show clearly how you got your answer.

Butter	$225 \times 2.5 =$	562.5 g ✓
Flour	$350 \times 2.5 =$	875g ✓
Sugar	$100 \times 2.5 =$	250g ✓
Mincemeat	$280 \times 2.5 =$	700g x
Eggs	$1 \times 2.5 =$	2.5 eggs ✓

Elaine doesn't have enough mincemeat to make 45 mince pies.

(Total for Question 2 is 4 marks)



- 3 The scatter graph shows some information about 10 cars, of the same type and make.  
The graph shows the age (years) and the value (£) of each car.

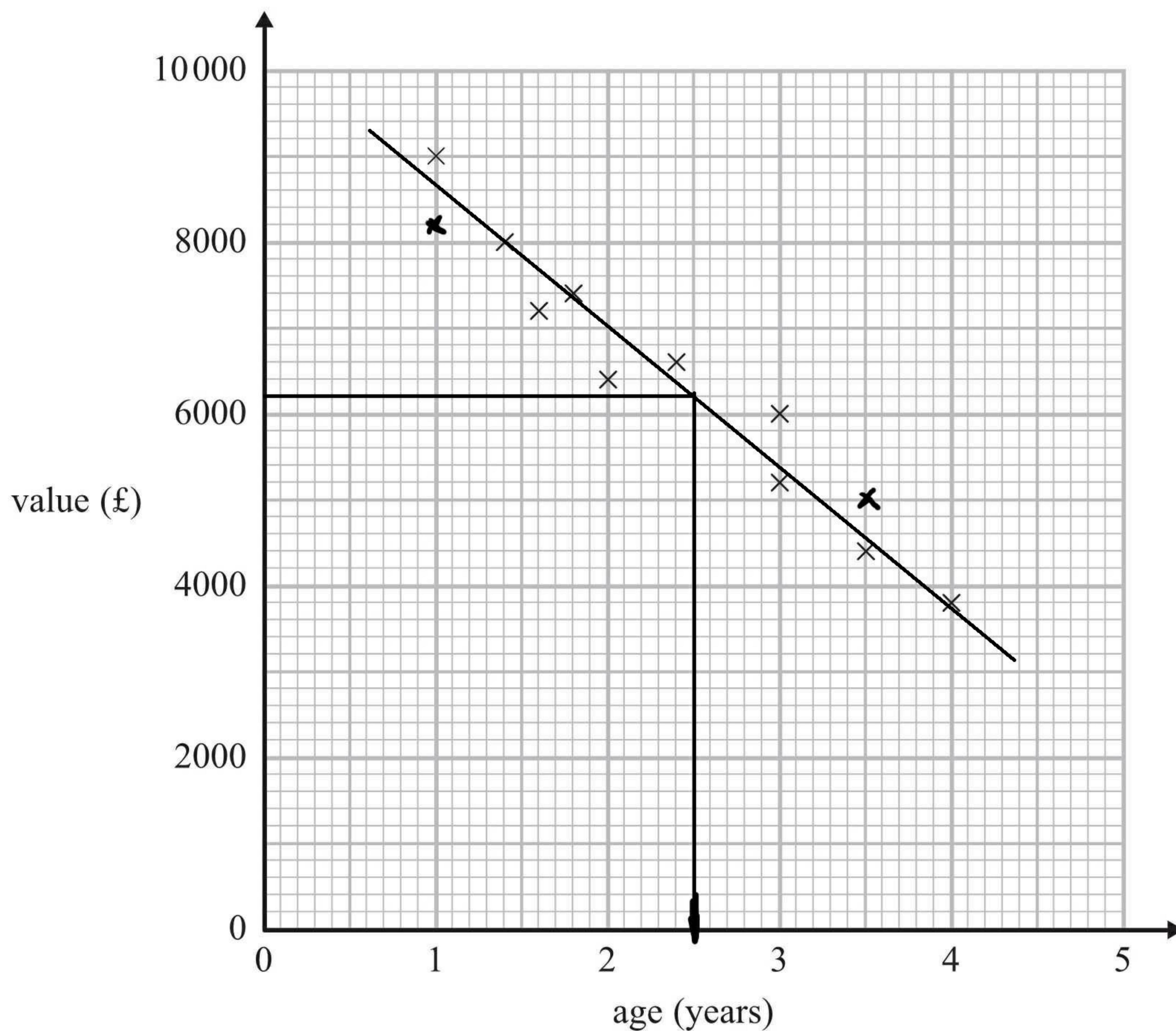

The table shows the age and the value of two other cars of the same type and make.

age (years)	1	3.5
value (£)	8200	5000

- (a) On the scatter graph, plot the information from the table. (1)
- (b) Describe the relationship between the age and the value of the cars.

as age increases, the car's value decreases

(1)

A car of the same type and make is  $2\frac{1}{2}$  years old.

- (c) Estimate the value of the car.

£ 6200

(2)

(Total for Question 3 is 4 marks)



4 Rhiana plays a game.

The probability that she will lose the game is 0.32

The probability that she will draw the game is 0.05

Rhiana is going to play the game 200 times.

Work out an estimate for the number of times Rhiana will win the game.

$$1 - 0.37 = 0.63$$

$$0.63 \times 200 = 126$$

126

(Total for Question 4 is 3 marks)



5 Mason is doing a survey to find out how many magazines people buy.

He uses this question on his questionnaire.

How many magazines do you buy?

<input type="checkbox"/>	<input type="checkbox"/>	<input type="checkbox"/>
0 to 4	4 to 8	8 to 12

(a) Write down **two** things wrong with this question.

1 there is no time scale

2 there is overlap: 4 and 8 are included in two boxes

(2)

(b) Write a better question for Mason to use on his questionnaire to find out how many magazines people buy.

How many magazines do you buy a month?

<input type="checkbox"/>	<input type="checkbox"/>	<input type="checkbox"/>	<input type="checkbox"/>
0	1-3	4-6	7 or more

(2)

Mason asks his friends at school to do his questionnaire.  
This may **not** be a good sample to use.

(c) Give **one** reason why.

they are likely to all be the same age

(1)

(Total for Question 5 is 5 marks)



6 Tame Valley is a company that makes yoghurt.

A machine fills trays of 20 pots with yoghurt.

In one hour, the machine fills a total of 15 000 pots.

Work out how many seconds the machine takes to fill each tray of 20 pots.

$$1 \text{ hour} = 3600 \text{ seconds}$$

$$15000 \text{ pots} = 750 \text{ trays}$$

$$\frac{3600}{750} = 4.8$$

4.8

seconds

(Total for Question 6 is 4 marks)





7 Colin, Dave and Emma share some money. 100%

Colin gets  $\frac{3}{10}$  of the money. 30%

Emma and Dave share the rest of the money in the ratio 3 : 2

5 parts

What is Dave's share of the money?

70% left

$$\frac{70}{5} = 14$$

each part is 14%

$$14 \times 2 = 28\%$$

28%

(Total for Question 7 is 4 marks)



8 The diagram shows the plan of a playground.

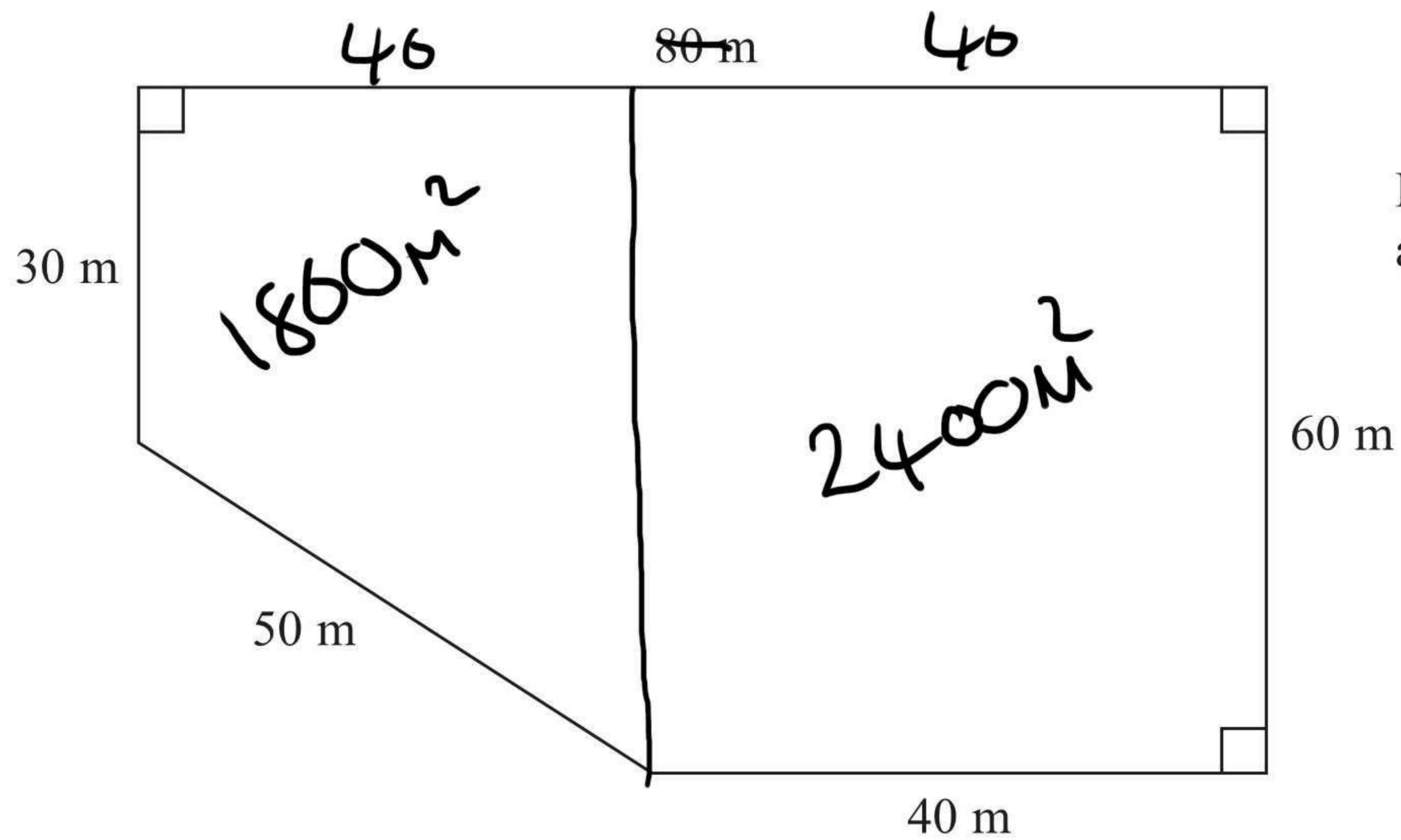

Bill is going to cover the playground with tarmac.  
It costs £2.56 to cover each square metre with tarmac.

Work out the total cost of the tarmac Bill needs.

$$\text{Total Area} = 4200 \text{ m}^2$$

$$4200 \times £2.56$$

£ 10752

(Total for Question 8 is 4 marks)



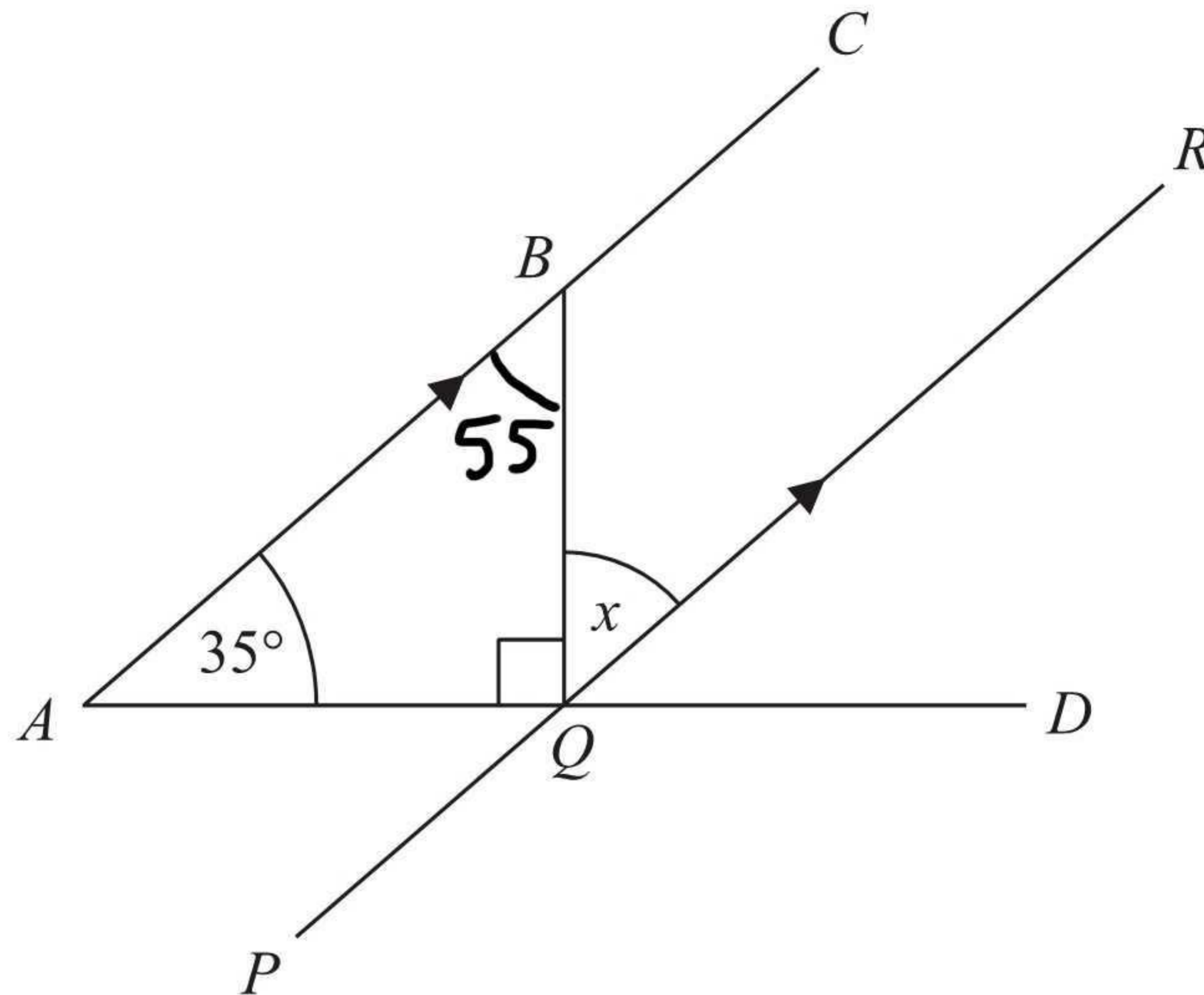

Diagram **NOT**  
accurately drawn

$ABC$ ,  $PQR$  and  $AQD$  are straight lines.  
 $ABC$  is parallel to  $PQR$ .

Angle  $BAQ = 35^\circ$   
Angle  $BQA = 90^\circ$

Work out the size of the angle marked  $x$ .  
Give reasons for each stage of your working.

$$\angle BQC = 55^\circ$$

Angles in a triangle  
add up to  $180^\circ$

$$x = 55^\circ$$

Alternate angles are equal

$$x = \dots 55 \dots^\circ$$

(Total for Question 9 is 4 marks)



10 The equation

$$x^3 + 2x = 110$$

has a solution between 4 and 5

Use a trial and improvement method to find this solution.

Give your answer correct to one decimal place.

You must show ALL your working.

$x$	$x^3 + 2x$	Comment
4.5	$(4.5)^3 + 2(4.5)$ $= 100.125$	too small
4.6	106.536	too small
4.7	113.223	too big
4.65	109.844625	too small

$$x = \underline{4.7}$$

(Total for Question 10 is 4 marks)



11  $XYZ$  is a right-angled triangle.

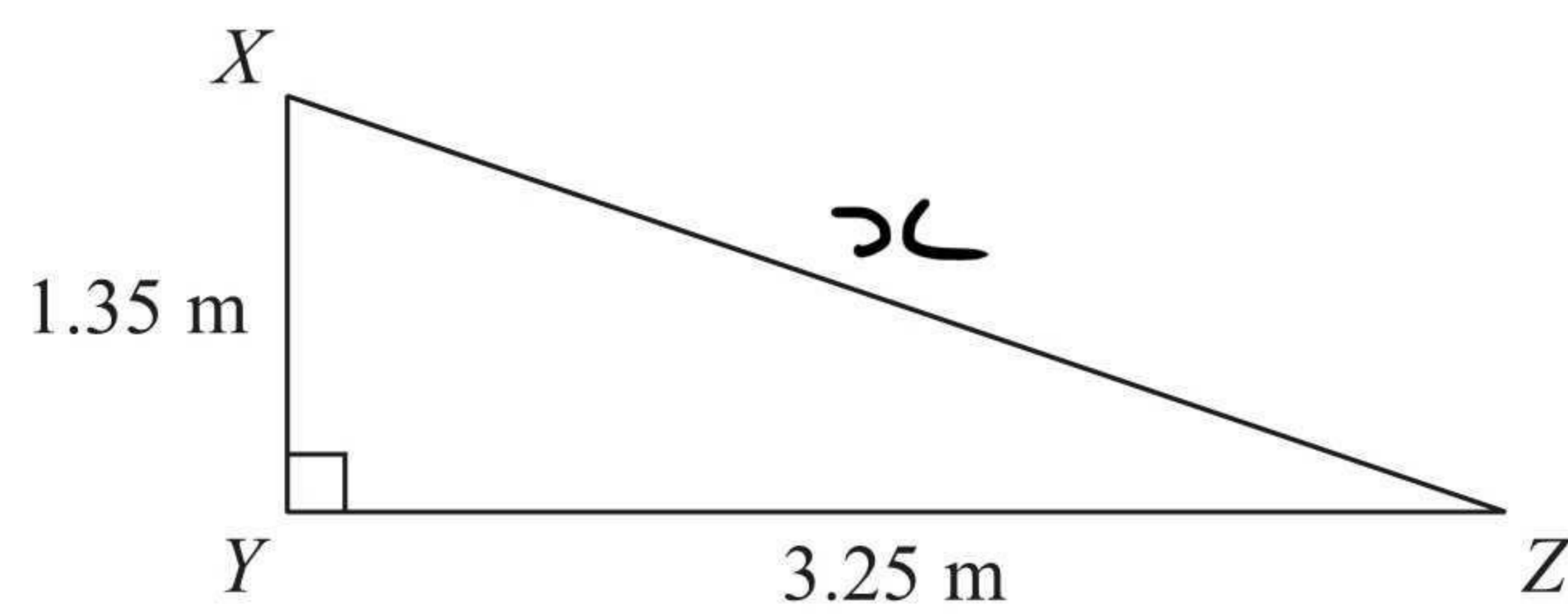

Diagram **NOT** accurately drawn

Calculate the length of  $XZ$ .

Give your answer correct to 3 significant figures.

$$\begin{aligned} a^2 + b^2 &= c^2 \\ (1.35)^2 + (3.25)^2 &= x^2 \\ 12.385 &= x^2 \\ 3.52 \text{ (3sf)} &= x \end{aligned}$$

..... 3.52 m

(Total for Question 11 is 3 marks)



12 (a) Solve  $3(x - 2) = x + 7$

$$3x - 6 = x + 7$$

$$2x - 6 = 7$$

$$2x = 13$$

$$x = 6.5$$

$$x = \frac{6.5}{(3)}$$

(b) Solve  $\frac{2 - y}{5} = 1$

$$2 - y = 5$$

$$2 = 5 + y$$

$$-3 = y$$

$$y = \frac{-3}{(2)}$$

(Total for Question 12 is 5 marks)



13

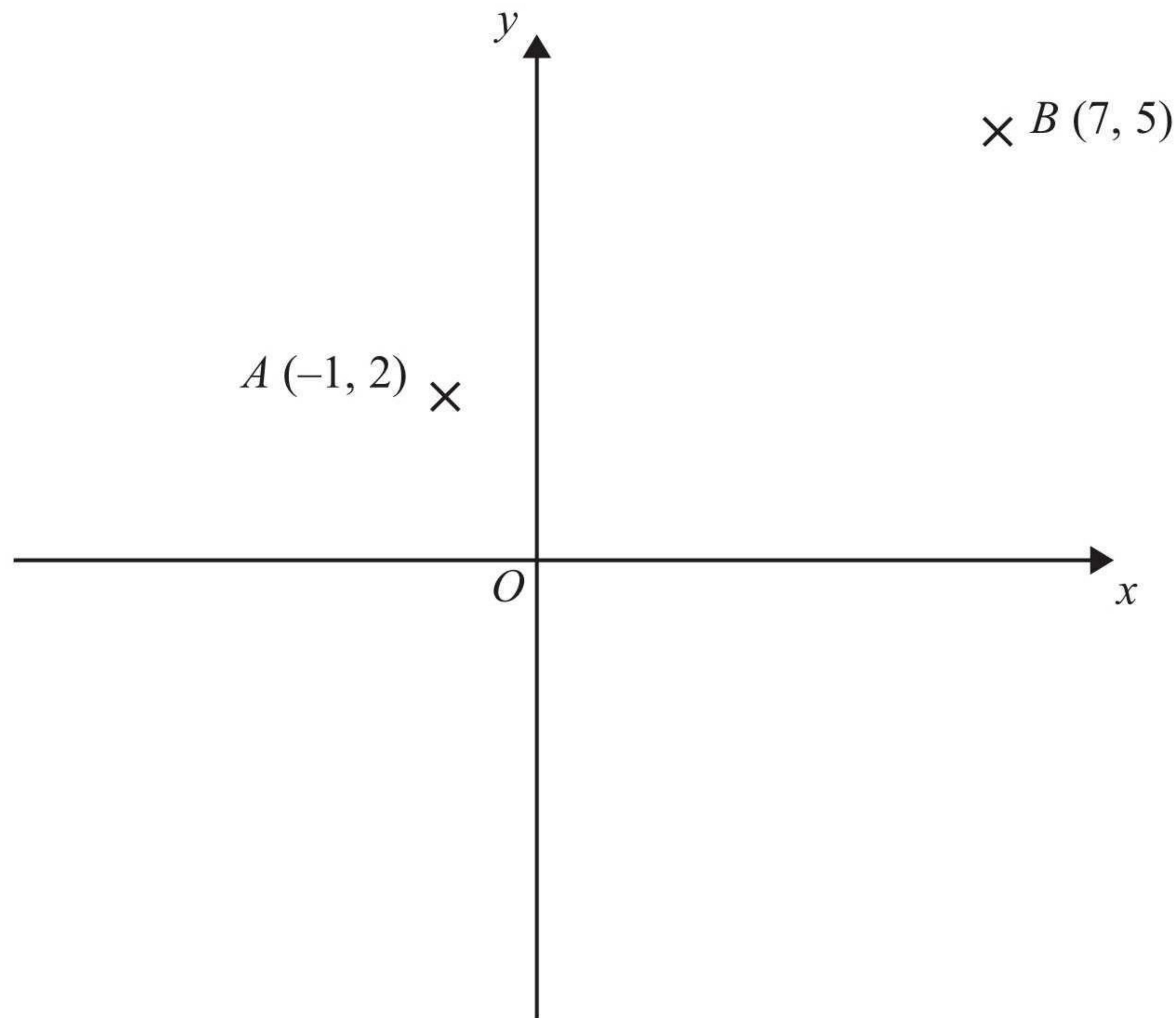

Diagram **NOT** accurately drawn

$A$  is the point  $(-1, 2)$   
 $B$  is the point  $(7, 5)$

$$\frac{-1 + 7}{2}, \frac{2 + 5}{2}$$

(a) Find the coordinates of the midpoint of  $AB$ .

$$(\underline{3}, \underline{3.5})$$

(2)

$P$  is the point  $(-4, 4)$   
 $Q$  is the point  $(1, -5)$

(b) Find the gradient of  $PQ$ .

$$\frac{-9}{5}$$

$$\underline{-1.8}$$

(2)

(Total for Question 13 is 4 marks)



\*14 Viv wants to invest £2000 for 2 years in the same bank.

### The International Bank

Compound Interest

4% for the first year

1% for each extra year

### The Friendly Bank

Compound Interest

5% for the first year

0.5% for each extra year

At the end of 2 years, Viv wants to have as much money as possible.

Which bank should she invest her £2000 in?

The International Bank

$$2000 \times 1.04 \\ = 2080$$

$$2080 \times 1.01 \\ = \pounds 2100.80$$

The Friendly Bank

$$2000 \times 1.05 \\ = 2100$$

$$2100 \times 1.005 \\ = \pounds 2110.50$$

She should invest her money in  
The Friendly Bank.

(Total for Question 14 is 4 marks)





15 (a) Complete the table of values for  $y = x^2 - 2x$

$x$	-2	-1	0	1	2	3	4
$y$	8	3	0	-1	0	3	8

(2)

(b) On the grid, draw the graph of  $y = x^2 - 2x$  for values of  $x$  from -2 to 4

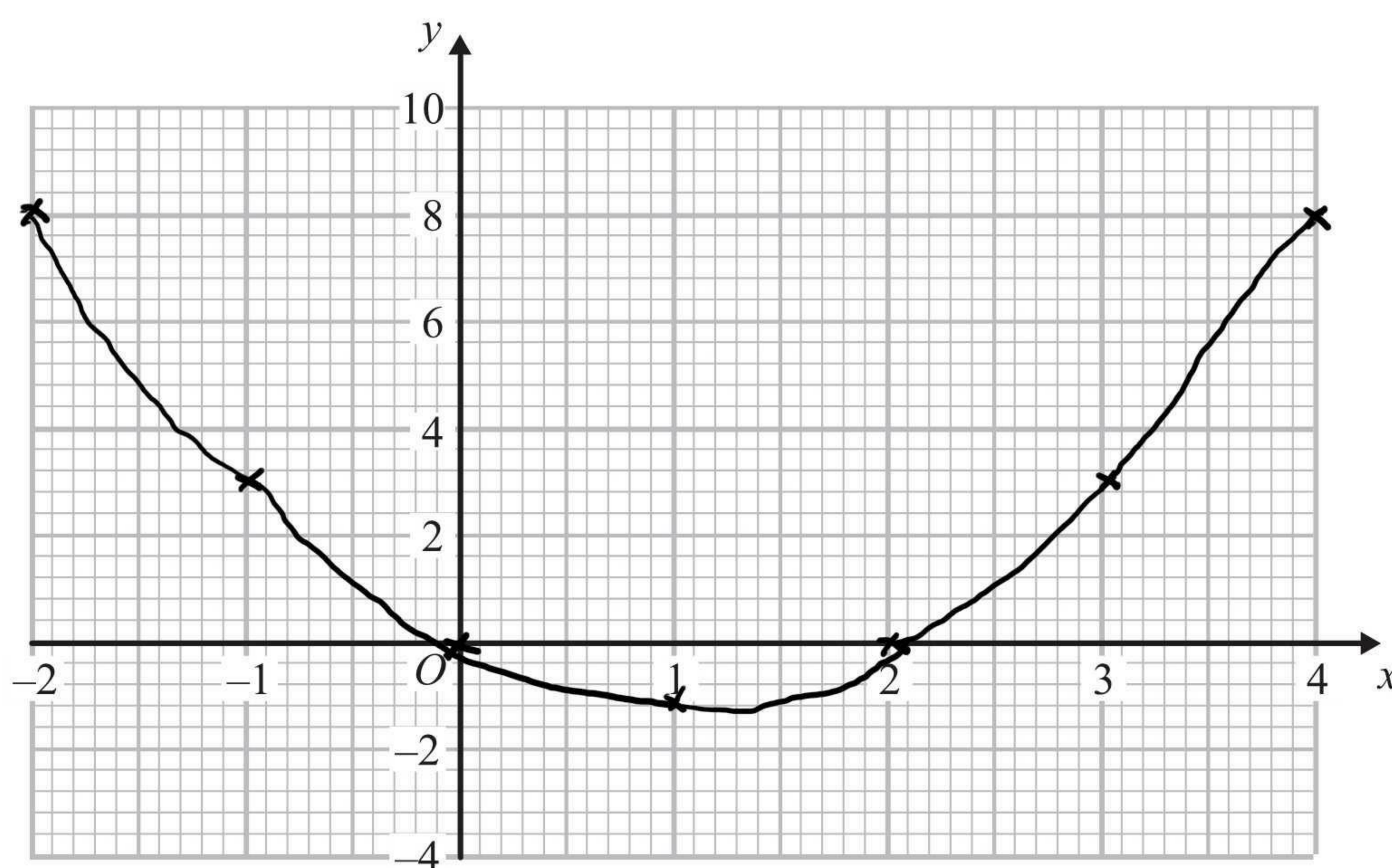

(2)

(c) Solve  $x^2 - 2x - 2 = 1$

$$x^2 - 2x - 3 = 0$$

$$(x - 3)(x + 1) = 0$$

$$x = 3 \quad x = -1$$

$$x = 3 \text{ or } x = -1$$

(2)

(Total for Question 15 is 6 marks)



\*16

Diagram NOT  
accurately drawn

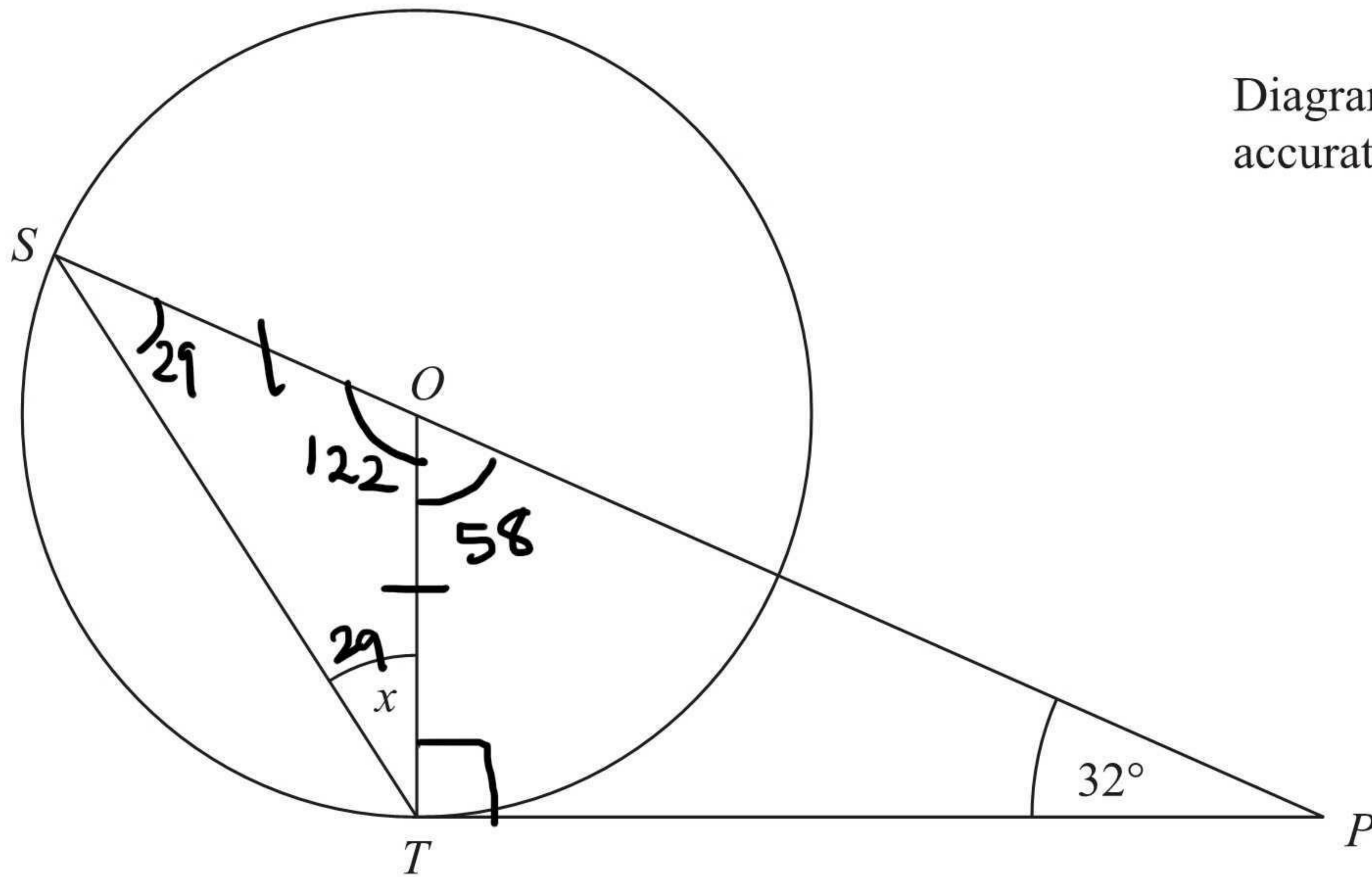

$S$  and  $T$  are points on the circumference of a circle, centre  $O$ .  
 $PT$  is a tangent to the circle.  
 $SOP$  is a straight line.

Angle  $OPT = 32^\circ$

Work out the size of the angle marked  $x$ .  
Give reasons for your answer.

$\hat{T}OP = 58^\circ$  Angles in triangle =  $180^\circ$   
 $\hat{S}OT = 122^\circ$  Angles on straight line =  $180^\circ$   
 $x = 29^\circ$  Angles at base of isosceles triangle are equal

..... 29 .....

(Total for Question 16 is 5 marks)



17 Some girls did a sponsored swim to raise money for charity.

The table shows information about the amounts of money (£) the girls raised.

Least amount of money (£)	10
Greatest amount of money (£)	45
Median	25
Lower quartile	16
Upper quartile	42

(a) On the grid, draw a box plot for the information in the table.

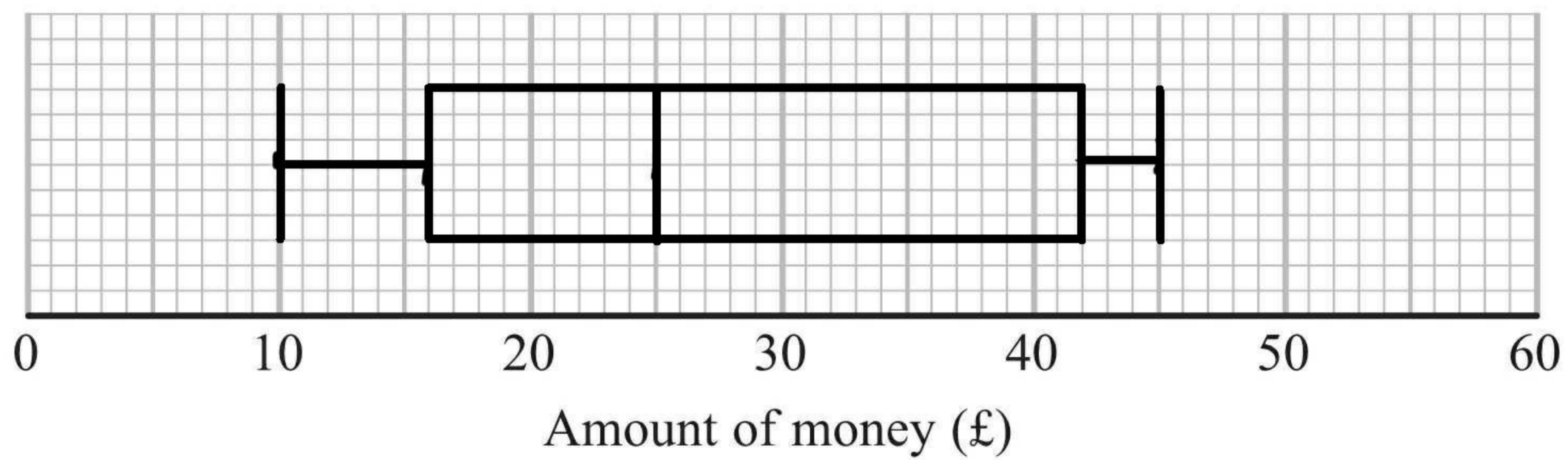

(2)

Some boys also did the sponsored swim.

The box plot shows information about the amounts of money (£) the boys raised.

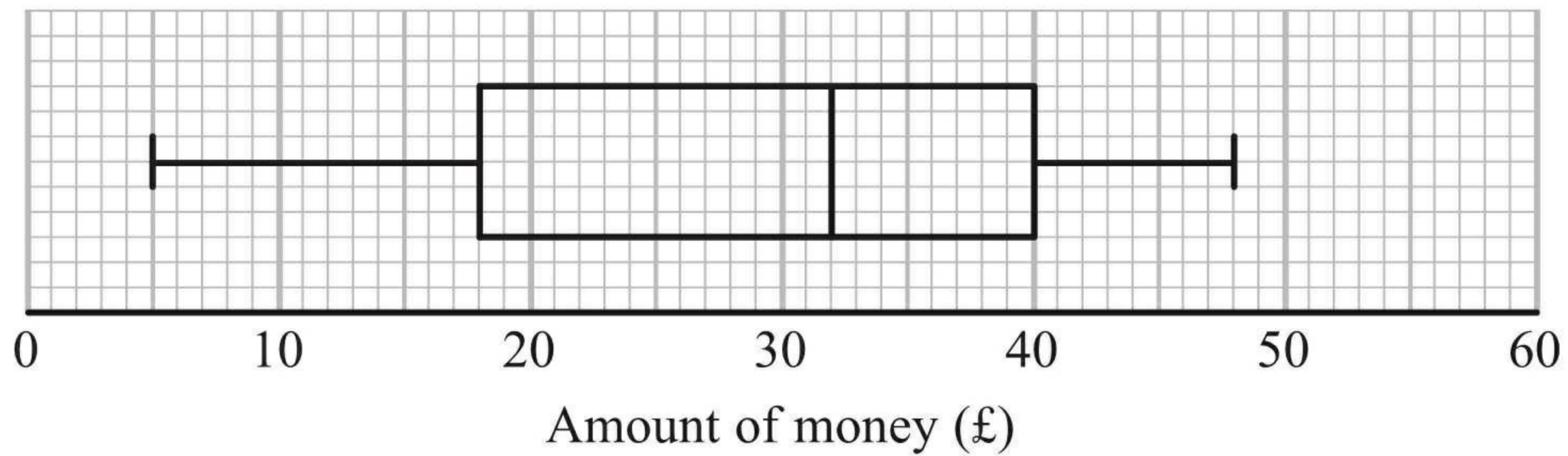

(b) Compare the amounts of money the girls raised with the amounts of money the boys raised.

The median amount raised by the boys was higher

The interquartile range of the girls was bigger

(2)

(Total for Question 17 is 4 marks)



18 Make  $p$  the subject of the formula  $y = 3p^2 - 4$

$$y + 4 = 3p^2$$
$$\frac{y + 4}{3} = p^2$$
$$\sqrt{\frac{y + 4}{3}} = p$$

$$p = \sqrt{\frac{y + 4}{3}}$$

(Total for Question 18 is 3 marks)

19 (a) Factorise  $6 + 9x$

$$3(2 + 3x)$$

(1)

(b) Factorise  $y^2 - 16$

$$(y + 4)(y - 4)$$

(1)

(c) Factorise  $2p^2 - p - 10$

$$(2p - 5)(p + 2)$$

(2)

(Total for Question 19 is 4 marks)



\*20 The diagram shows a ladder leaning against a vertical wall.

Diagram NOT  
accurately drawn

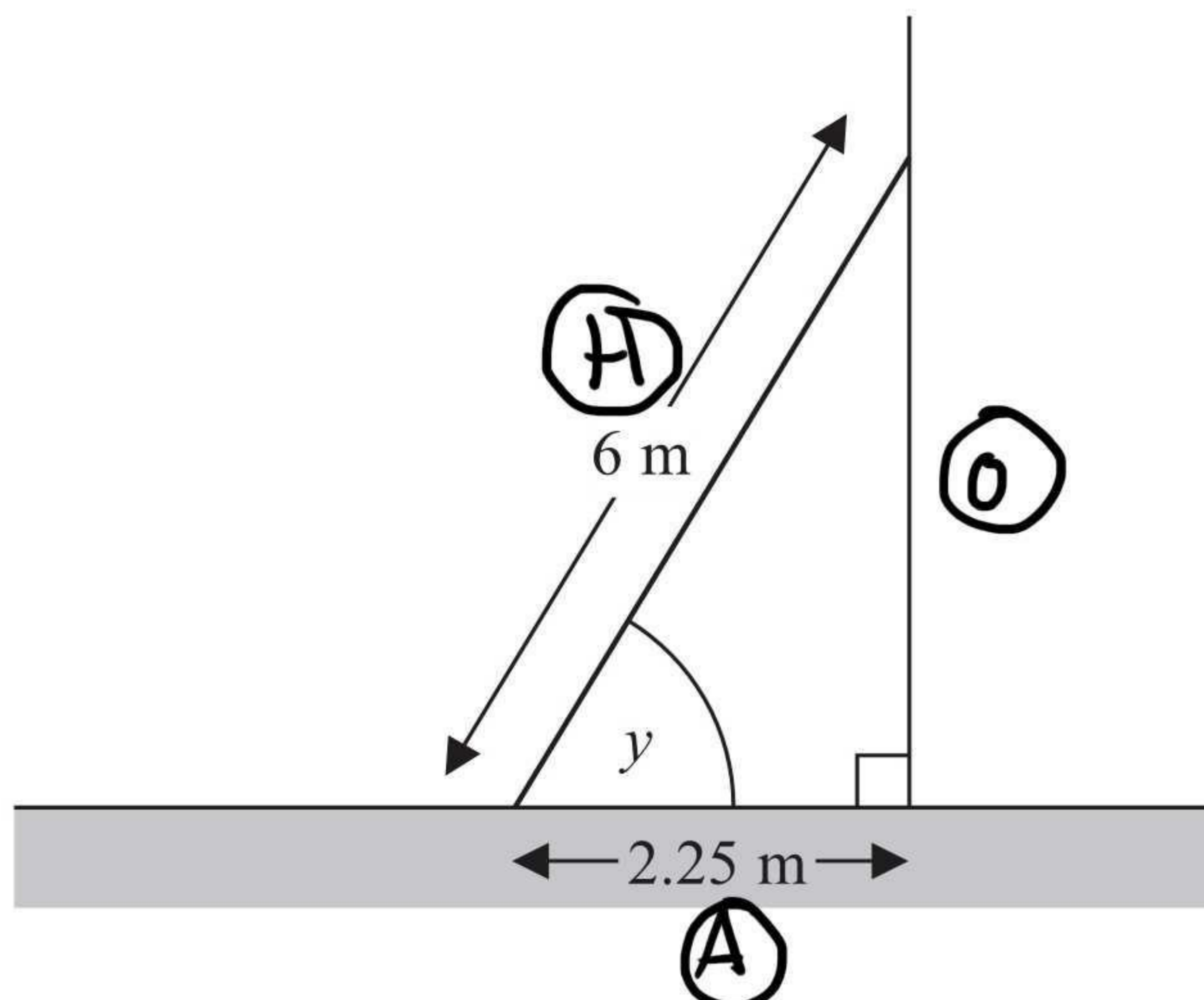

The ladder stands on horizontal ground.

The length of the ladder is 6 m.

The bottom of the ladder is 2.25 m from the bottom of the wall.

A ladder is safe to use when the angle marked  $y$  is about  $75^\circ$ .

Is the ladder safe to use?

You must show all your working.

$$\cos(y) = \frac{2.25}{6}$$

$$y = \cos^{-1}\left(\frac{2.25}{6}\right)$$

$$y = 67.98^\circ \text{ (2dp)}$$

The angle is not 'about'  $75^\circ$ , so  
the ladder is not safe.

(Total for Question 20 is 3 marks)



21 In Holborn School there are

460 students in Key Stage 3

320 students in Key Stage 4

165 students in Key Stage 5

Nimer is carrying out a survey.

He needs a sample of 100 students stratified by Key Stage.

Work out the number of students from Key Stage 3 there should be in the sample.

$$\frac{460}{945} \times 100 = 48.677\dots$$

49

(Total for Question 21 is 2 marks)

22  $h$  is inversely proportional to the square of  $r$ .

When  $r = 5$ ,  $h = 3.4$

Find the value of  $h$  when  $r = 8$

$$h = \frac{k}{r^2}$$
$$3.4 = \frac{k}{5^2}$$
$$85 = k$$

$$h = \frac{85}{r^2}$$
$$h = \frac{85}{(8)^2}$$

$h = 1.33$  (3sf)

(Total for Question 22 is 3 marks)



23 Dan does an experiment to find the value of  $\pi$ .  
He measures the circumference and the diameter of a circle.

He measures the circumference,  $C$ , as 170 mm to the nearest millimetre.  
He measures the diameter,  $d$ , as 54 mm to the nearest millimetre.

Dan uses  $\pi = \frac{C}{d}$  to find the value of  $\pi$ .

Calculate the upper bound and the lower bound for Dan's value of  $\pi$ .

$$\text{Upper Bound} = \frac{170.5}{53.5} = 3.1869\dots$$

$$\text{Lower Bound} = \frac{169.5}{54.5} = 3.1100\dots$$

$$\text{upper bound} = 3.19 \text{ (3sf)}$$

$$\text{lower bound} = 3.11 \text{ (3sf)}$$

(Total for Question 23 is 4 marks)



24  $ABC$  is a triangle.

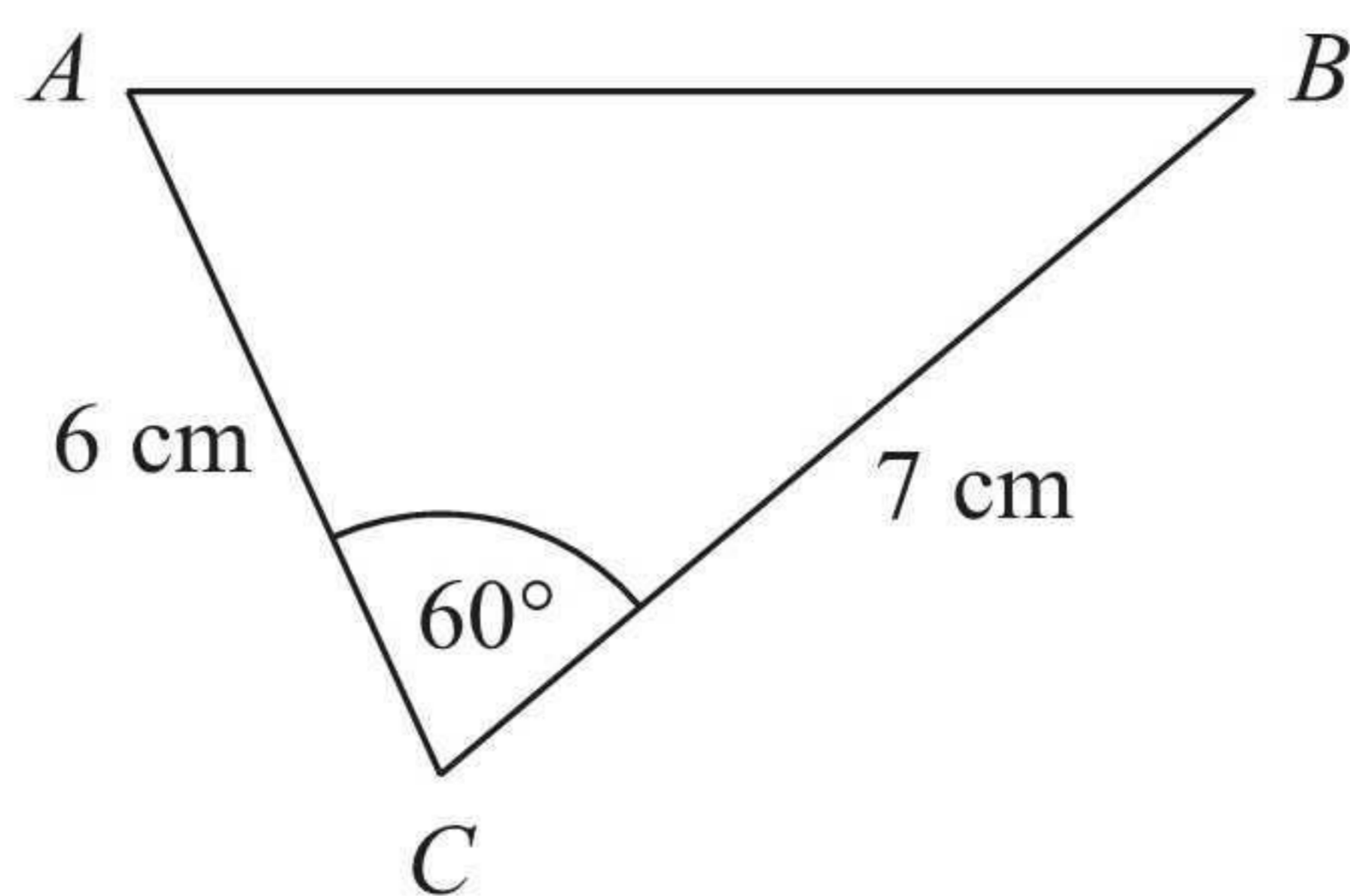

Diagram **NOT** accurately drawn

- (a) Work out the area of triangle  $ABC$ .  
Give your answer correct to 3 significant figures.

$$\frac{1}{2} ab \sin C$$

$$\frac{1}{2} (6)(7) \sin(60)$$

$$\underline{18.2} \text{ cm}^2$$

(2)

- (b) Work out the length of the side  $AB$ .  
Give your answer correct to 3 significant figures.

$$a^2 = b^2 + c^2 - 2bc \cos A$$

$$x^2 = (6)^2 + (7)^2 - 2(6)(7) \cos(60)$$

$$x^2 = 43$$

$$x = 6.56 \text{ (3sf)}$$

$$\underline{6.56} \text{ cm}$$

(3)

(Total for Question 24 is 5 marks)





25 Solve the simultaneous equations  $x^2 + y^2 = 9$   
 $x + y = 2$

Give your answers correct to 2 decimal places.

$$x = 2 - y$$

$$(2 - y)^2 + y^2 = 9$$

$$(2 - y)(2 - y) + y^2 = 9$$

$$4 - 2y - 2y + y^2 + y^2 = 9$$

$$2y^2 - 4y + 4 = 9$$

$$2y^2 - 4y - 5 = 0$$

$$a = 2$$

$$b = -4$$

$$c = -5$$

$$y = \frac{-(-4) \pm \sqrt{(-4)^2 - 4(2)(-5)}}{2(2)}$$

$$= 2.87 \quad \text{or} \quad -0.87$$

(2dp)                      (2dp)

$$x + (2.87) = 2$$

$$x = -0.87$$

$$x + (-0.87) = 2$$

$$x = 2.87$$

$$x = -0.87 \quad y = 2.87$$

$$\text{or } x = 2.87 \quad y = -0.87$$

(Total for Question 25 is 6 marks)

TOTAL FOR PAPER IS 100 MARKS

